

KONSTRUKCIJE

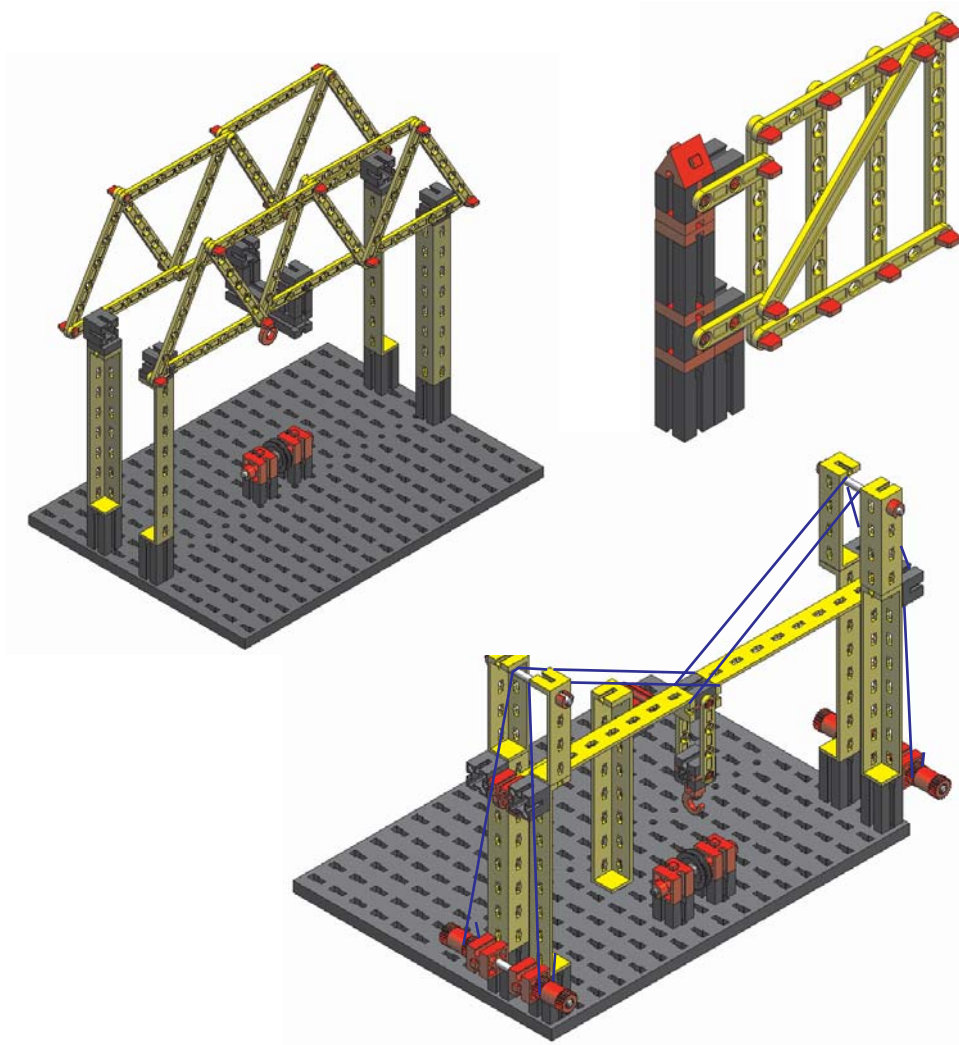

KONSTRUKCIJE









40000 Čakovec,
T. Goričanca 2
tel: 040/364-445
fax:040/364-230



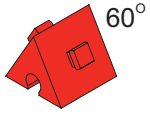
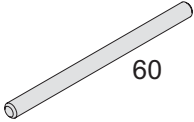
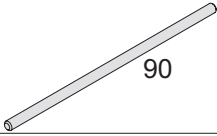
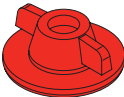
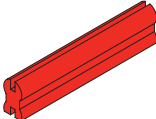

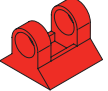
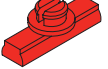
WEB: <http://www.didakta.hr>
E-mail: didakta@ck.t-com.hr

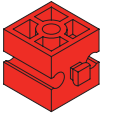
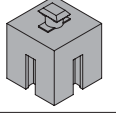
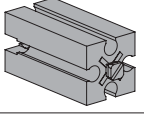
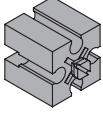



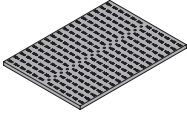
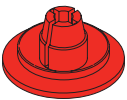
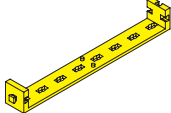
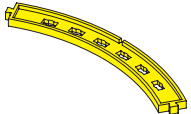
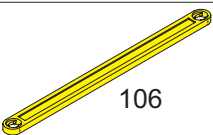
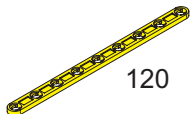
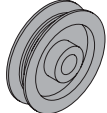
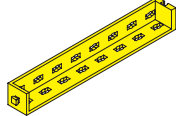
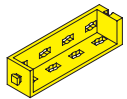

KONSTRUKCIJE

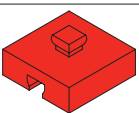
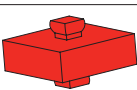
ELEMENTI

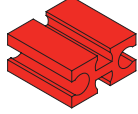
1	 60°	31010
3	 60	31032
2	 90	31040
4		31058
1		31061
2		31426
2		31436
4		31848
4		31982
6		32064
6		32850
6		32879
4		32881
2		32882

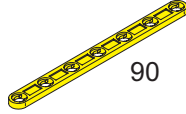
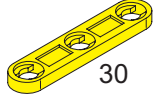
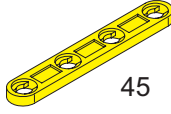
1		32985
4		35031
3		35054
3		35055
1	 106	35059
2	 120	35060
1		35797
5	 36294	36294
4	 36297	36297
10	 4	36323
8	 6	36324
4	 8	36457
3		37237
4		37238

2		37468
6		37679
1		38225
22	 90	38531
2	 30	38538
2	 45	38541
2	 90 cm	špagica duga
1	 30 cm	špagica kratka

KONSTRUKCIJE- OSNOVNE

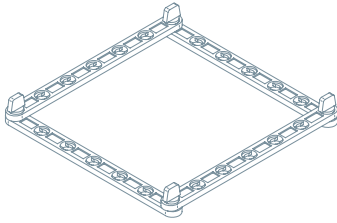

Umetnuti u rupu, zaokrenuti za 90°, provući kroz drugu letvicu i opet zaokrenuti za 90° tako da osigurač drži letvice zajedno.

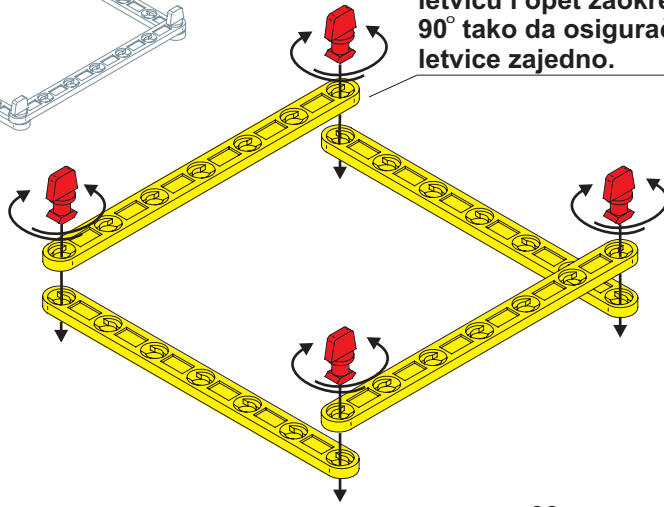

1

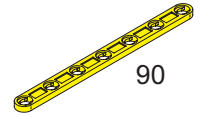

90

x4 - 38531



4

x4 - 36323

90

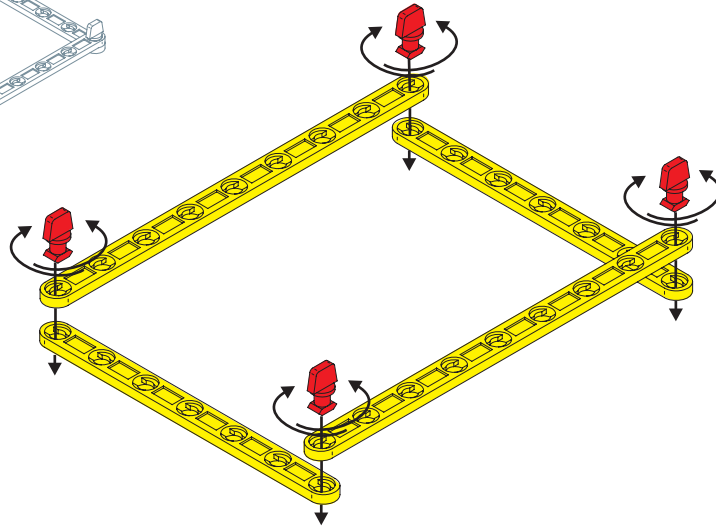
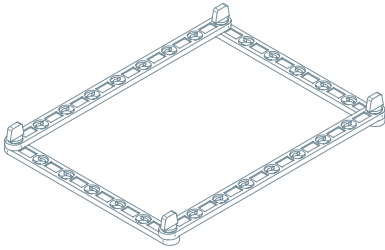

2

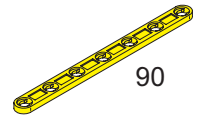

90

x4 - 38531



4

x4 - 36323

90

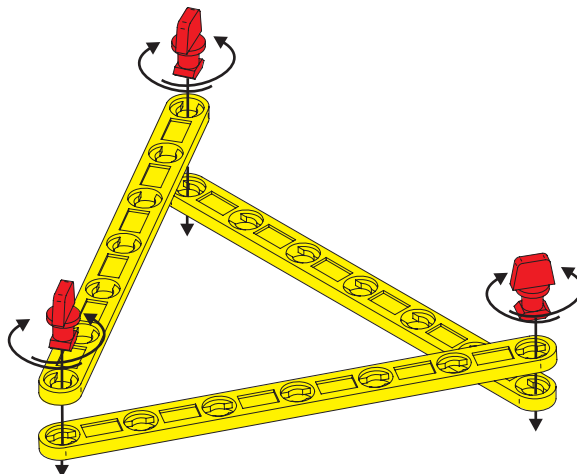
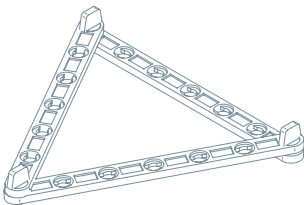

3

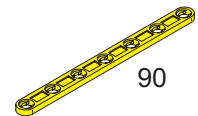

90

x3 - 38531





4

x3 - 36323

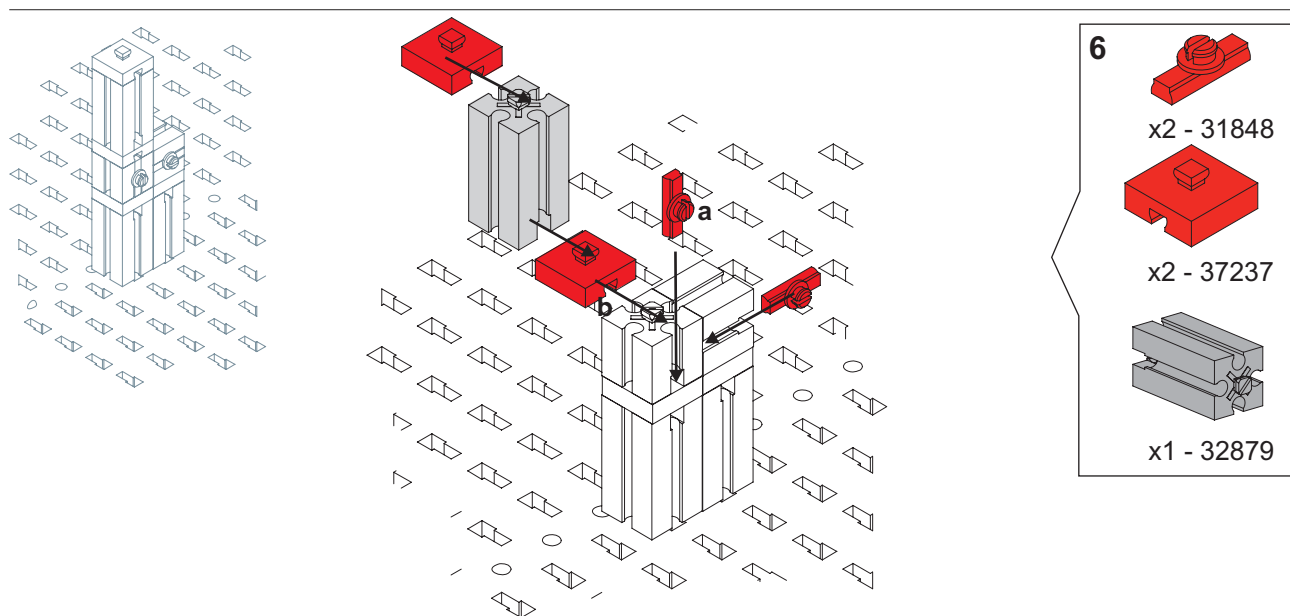
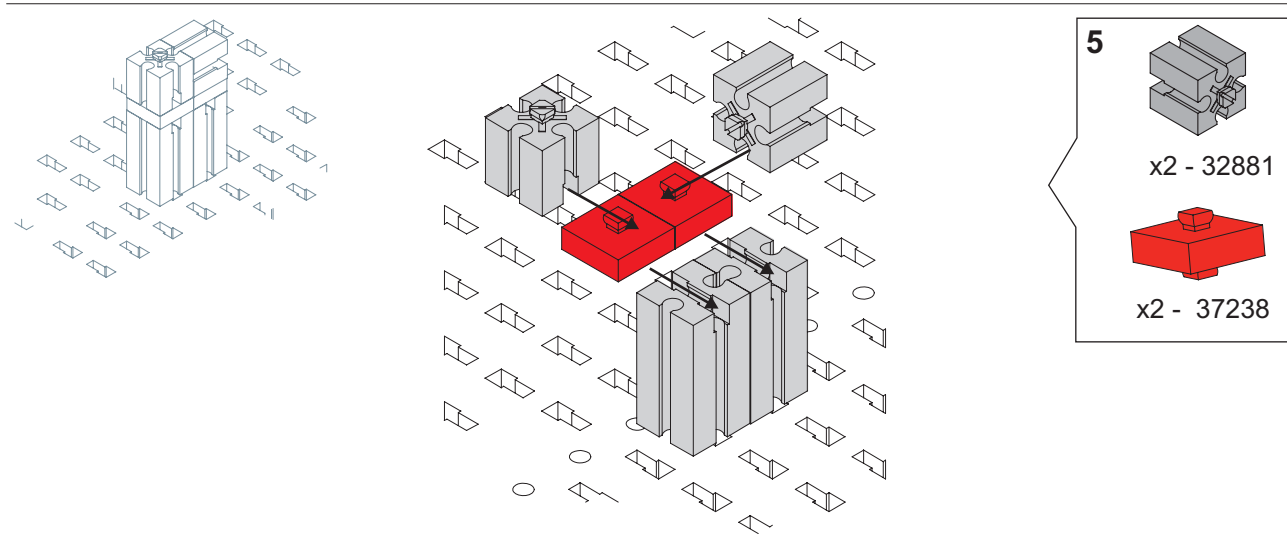
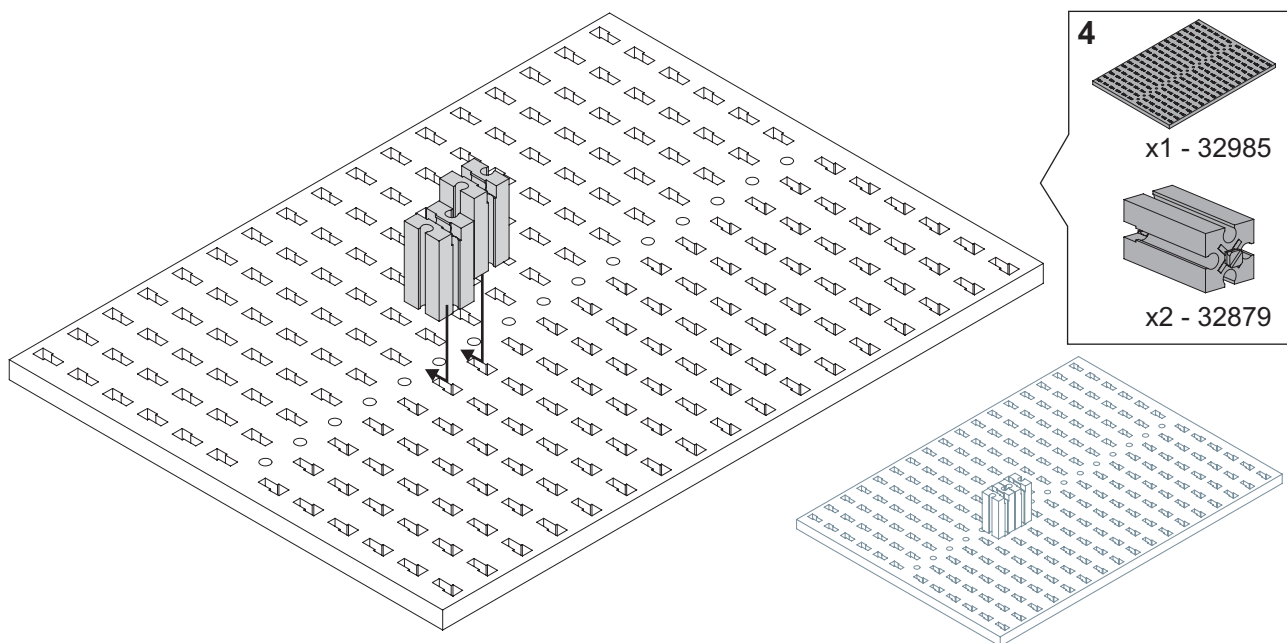
90

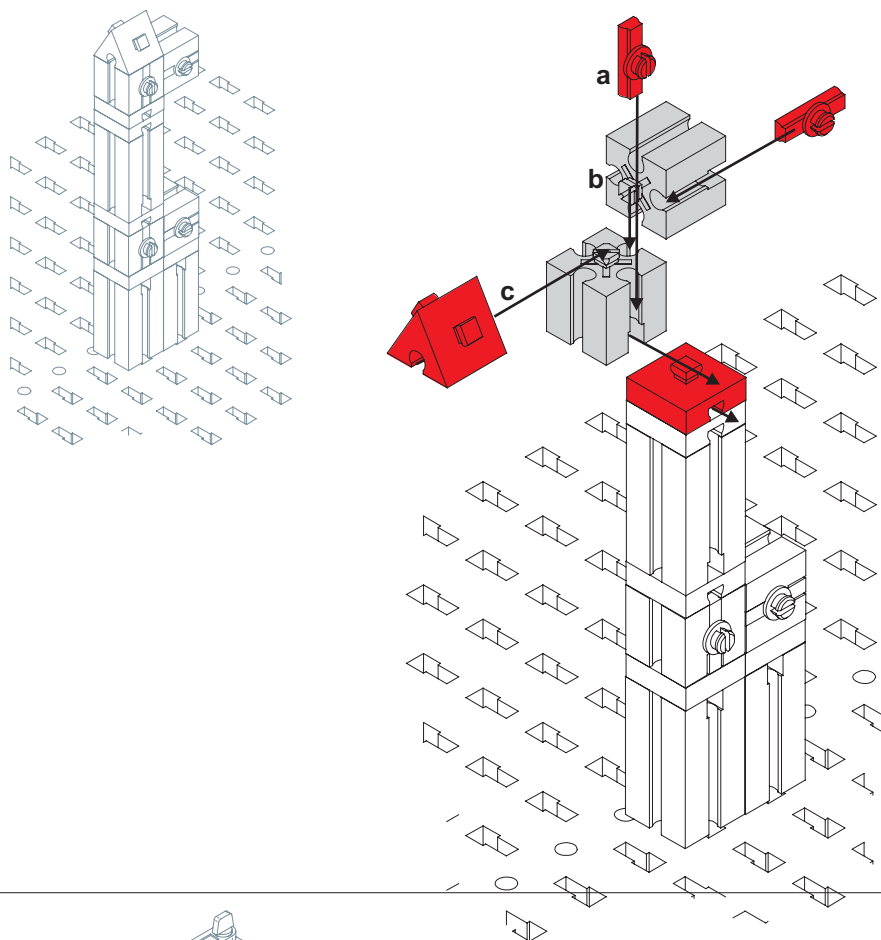

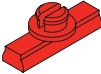
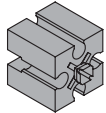

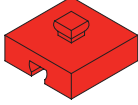

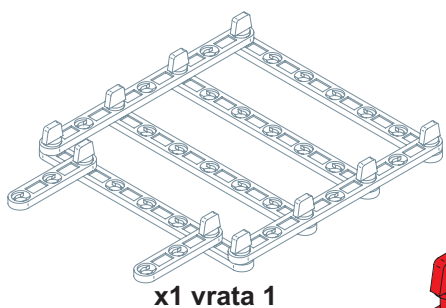
- 7**
-  x2 - 31848
 -  x2 - 32881
 -  60° x1 - 31010
 -  x1 - 37237

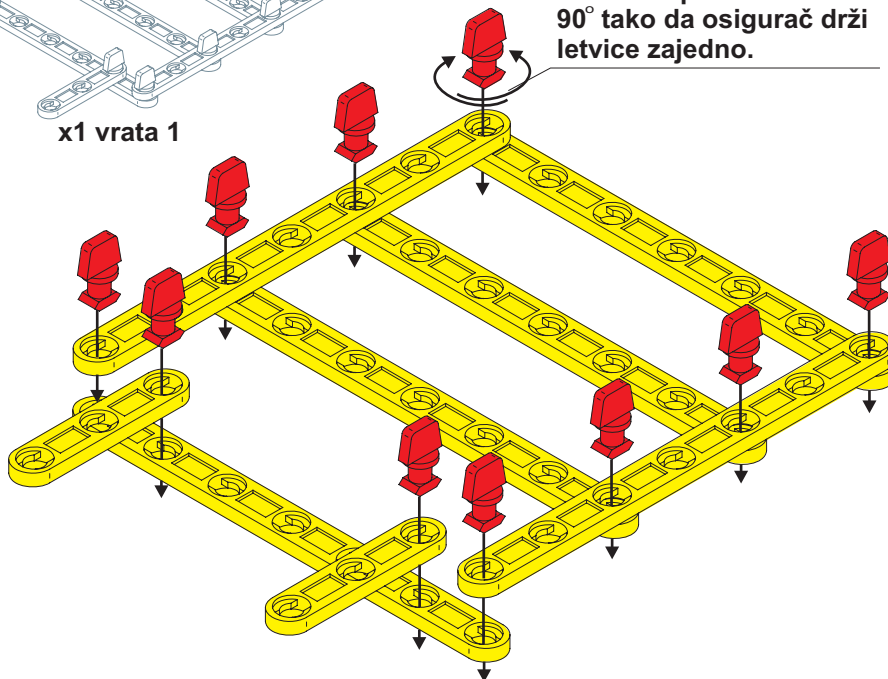

x1 vrata 1

Umetnuti u rupu, zaokrenuti za 90°, provući kroz drugu letvicu i opet zaokrenuti za 90° tako da osigurač drži letvice zajedno.

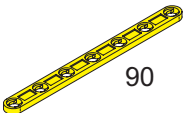
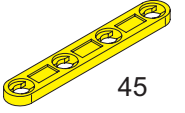

- 8**
-  90 x6 - 38531
 -  45 x2 - 38541
 -  4 x10 - 36323

KONSTRUKCIJE-VRATA

4

Nataknuti vrata na nosače
i ispitati konstrukciju

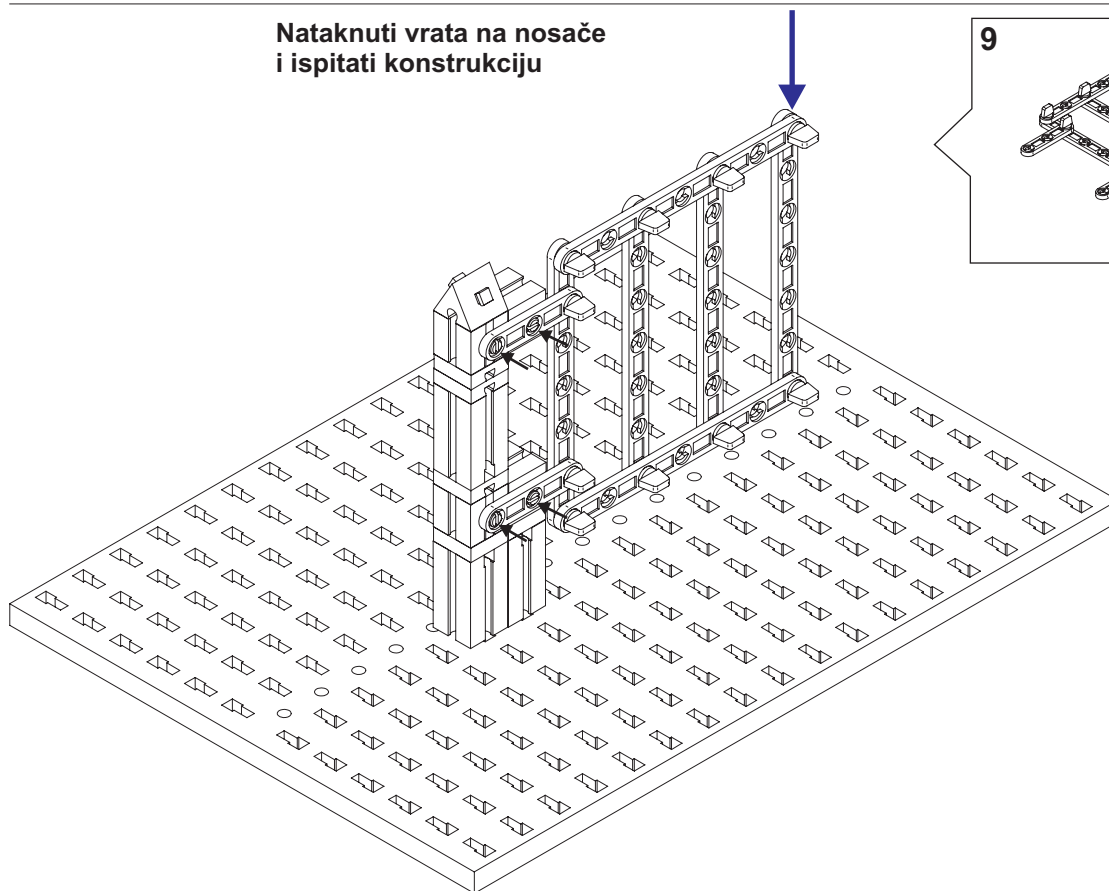

9

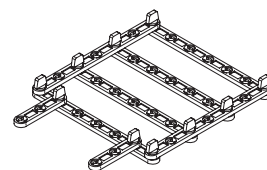

x1 vrata 1

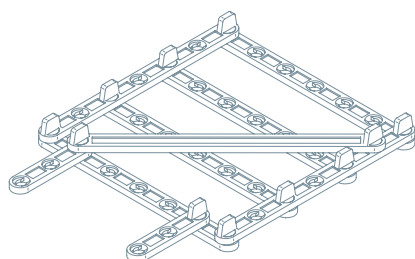

x1 vrata 2

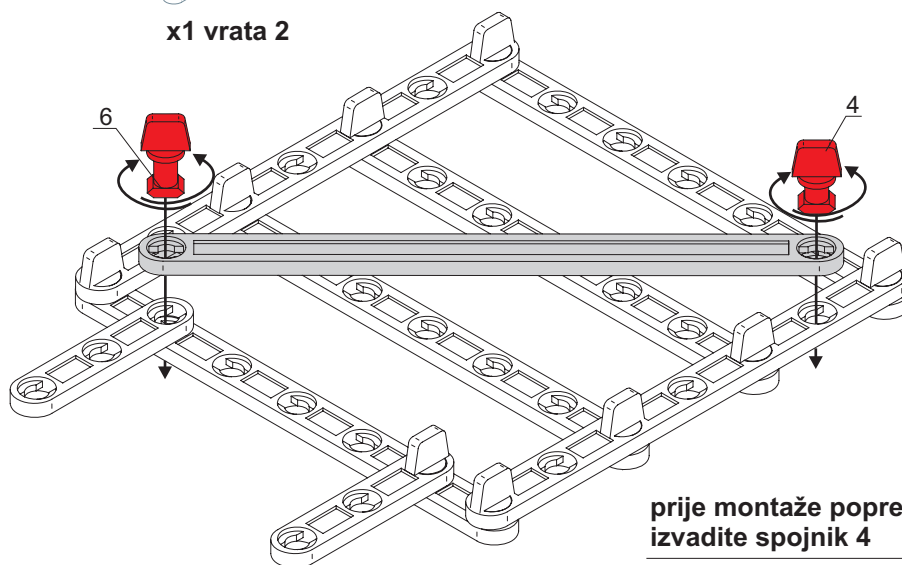

prije montaže poprečne letvice
izvadite spojnik 4

10

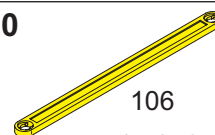

106

x1 - 35059



4

x1 - 36323



6

x1 - 36324

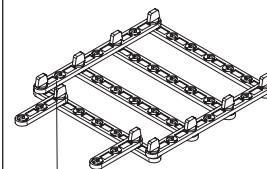

x1 vrata 1

Nataknuti vrata na nosače
i ispitati konstrukciju

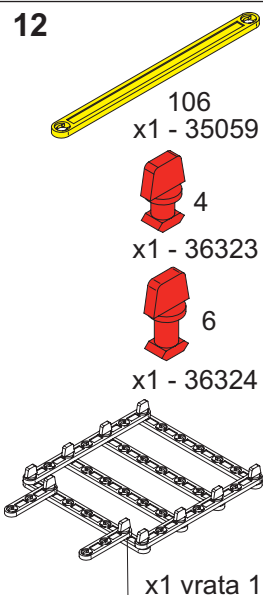
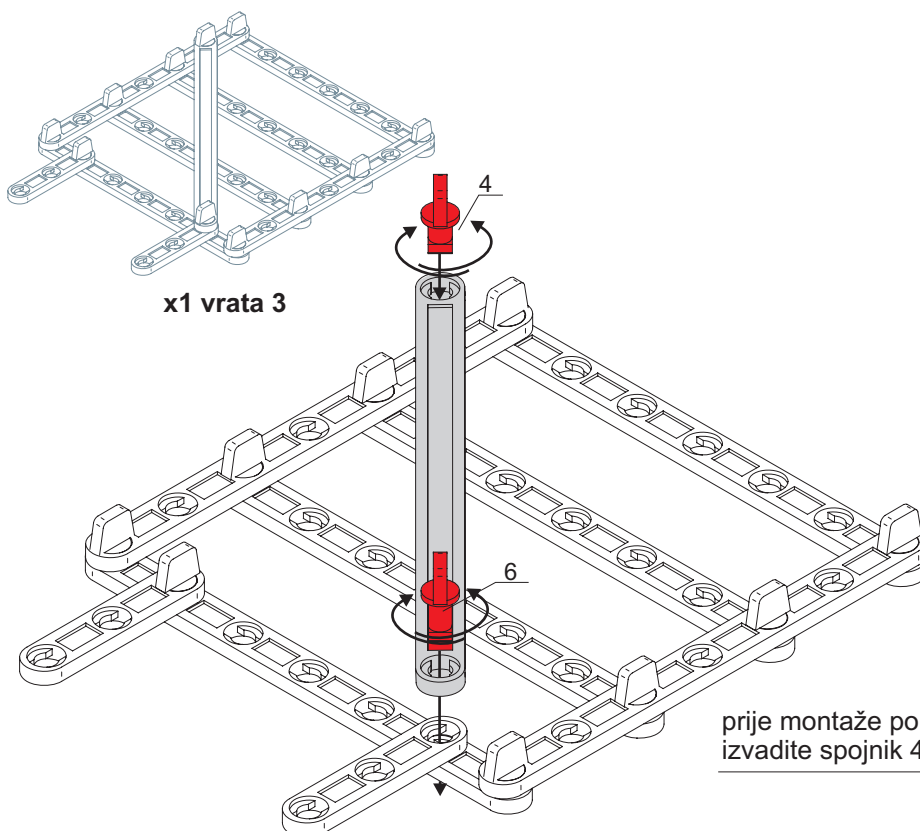
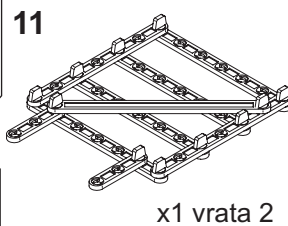
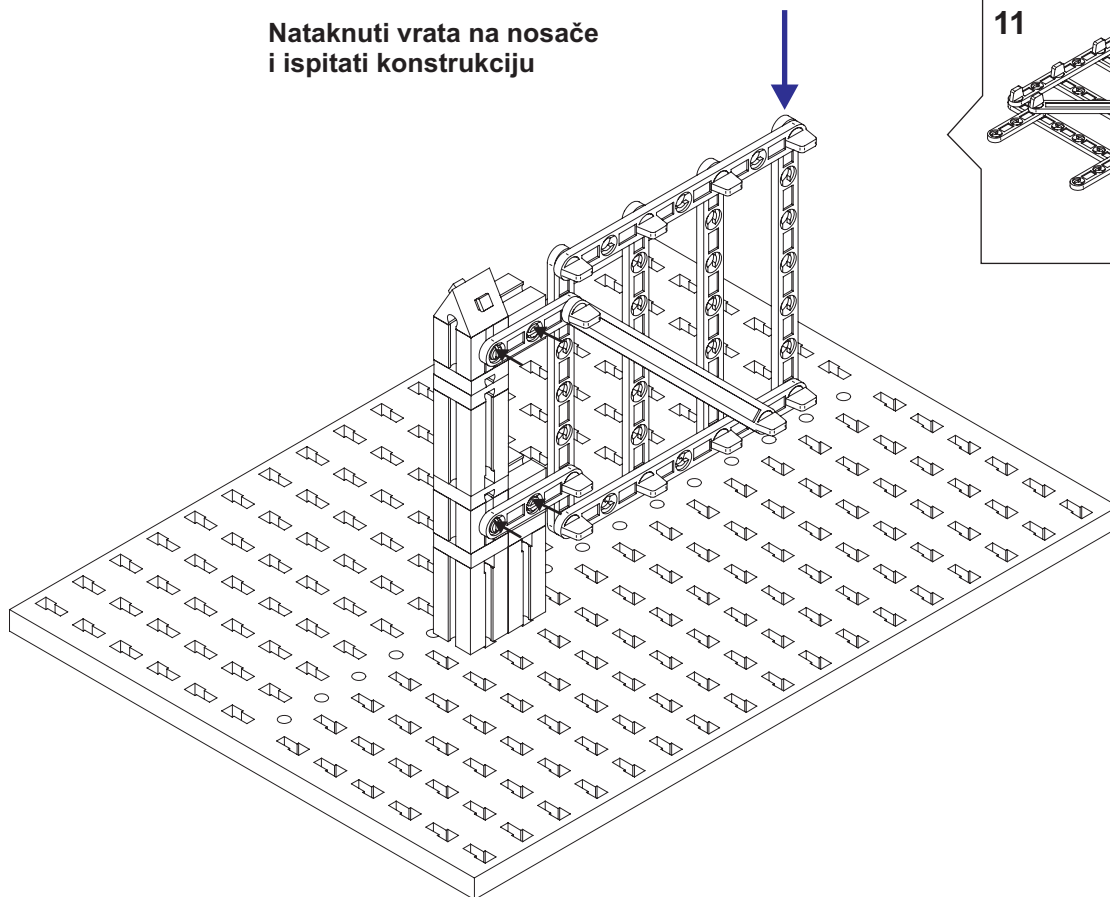

prije montaže poprečne letvice
izvadite spojnik 4

Nataknuti vrata na nosače
i ispitati konstrukciju

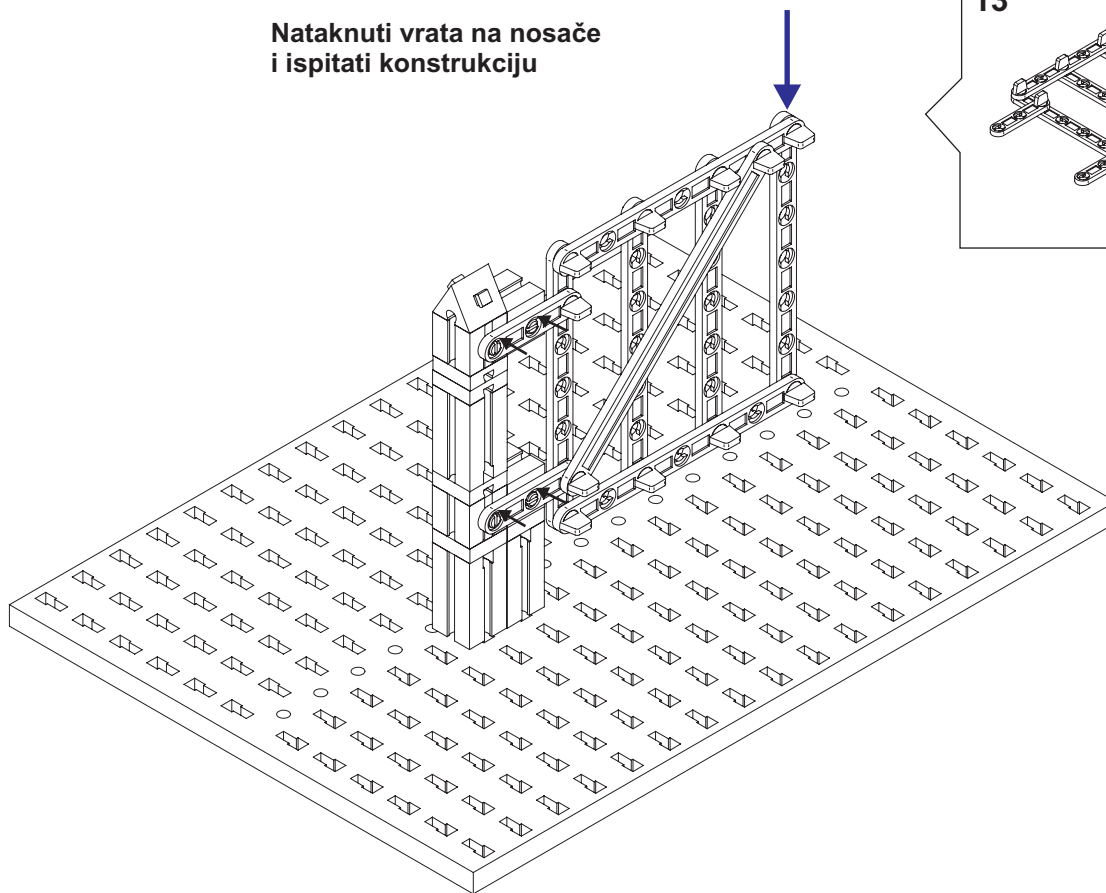

13

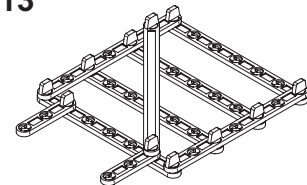

x1 vrata 3

KONSTRUKCIJE- POSTOLJE A

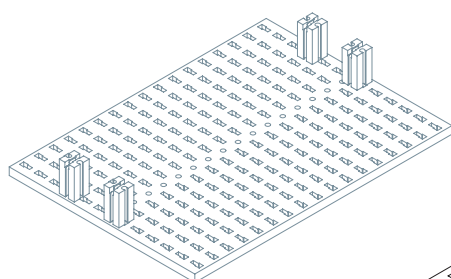

postolje A

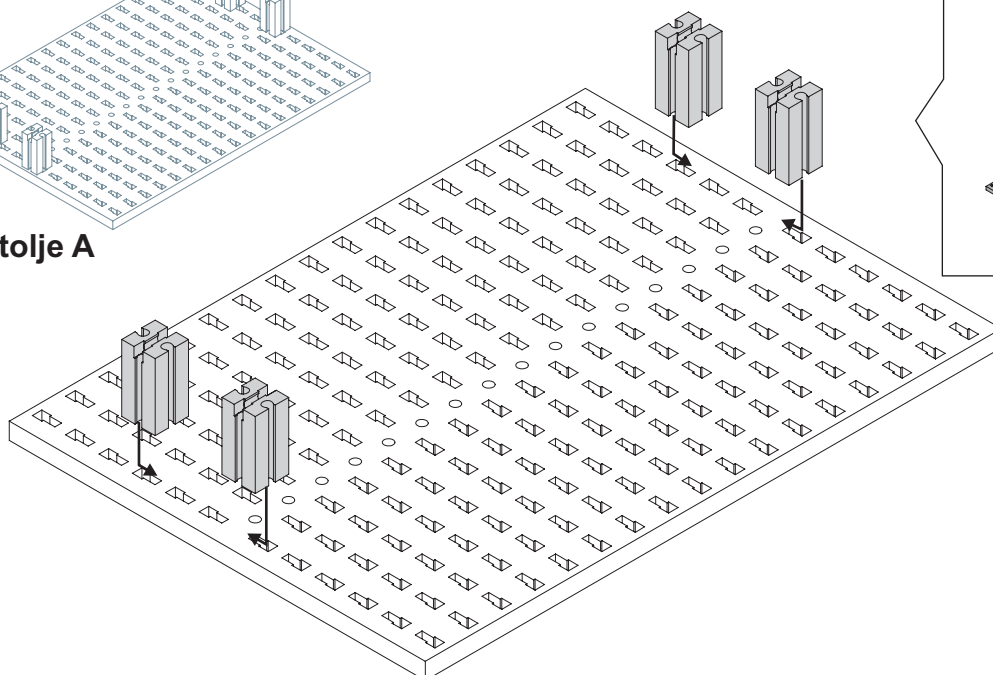

1

x4 - 32879

x1 - 32985

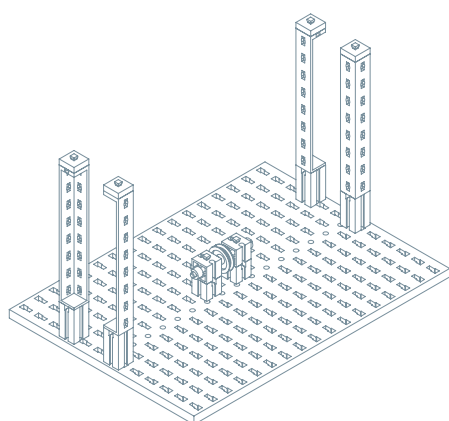

postolje A

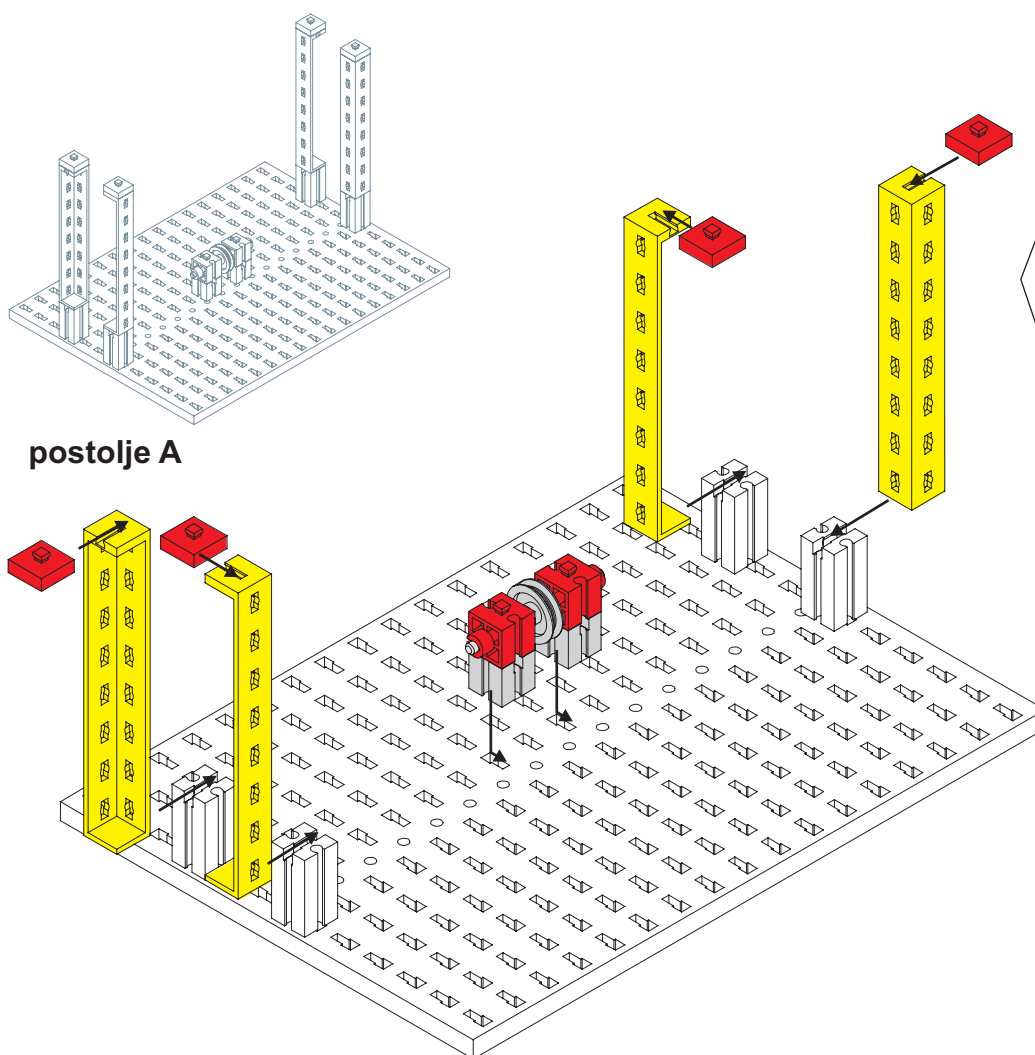

2

x1 sklop 1
(str. 8)

x4 - 36294

x4 - 37238

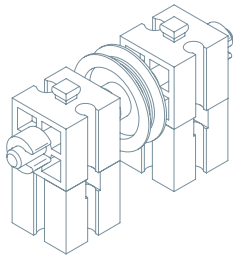

KONSTRUKCIJE- MOST "A"

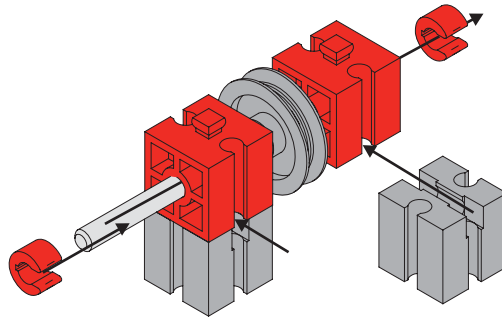

x1 sklop 1

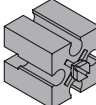

60

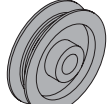
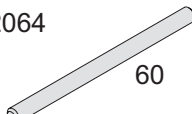

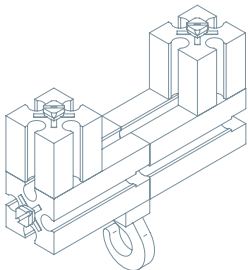
- 1**
-  x2 - 37679
 -  x2 - 32881
 -  x2 - 32064
 -  x1 - 35797
 -  60
x1 - 31032

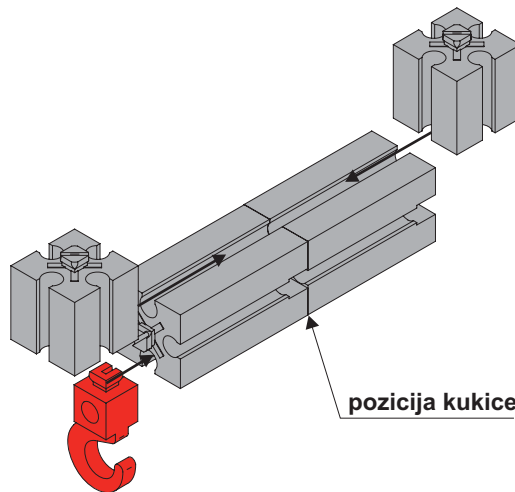

x1 sklop 2



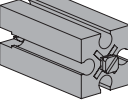

pozicija kukice

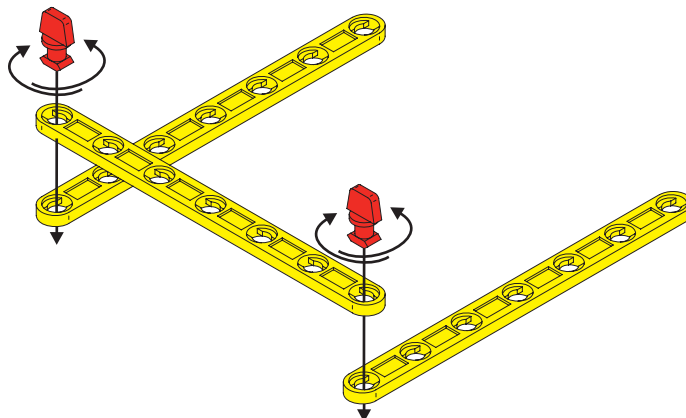
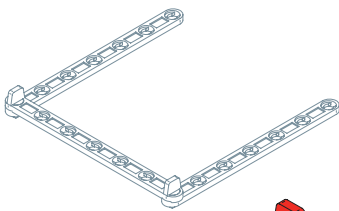
- 2**
-  x2 - 32882
 -  x2 - 32879
 -  x1 - 38225



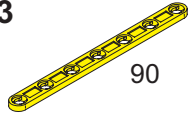

90

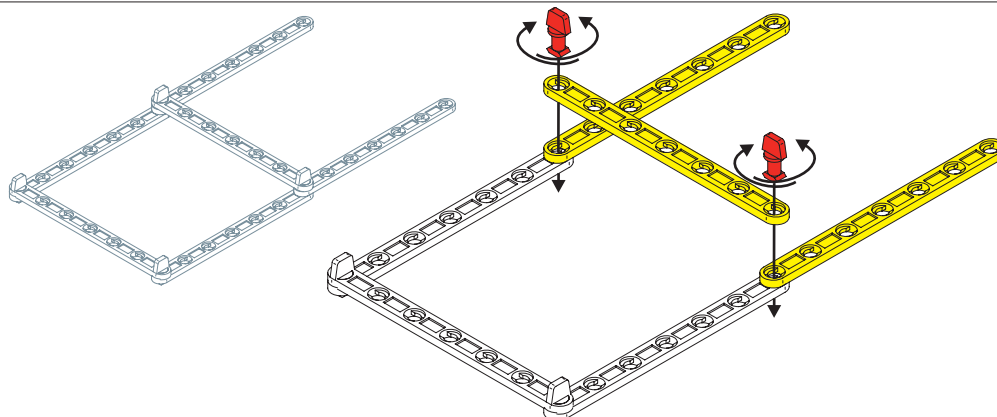

- 3**
-  90
x3 - 38531
 -  4
x2 - 36323

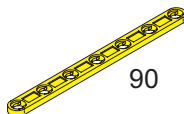
KONSTRUKCIJE- MOST "A"

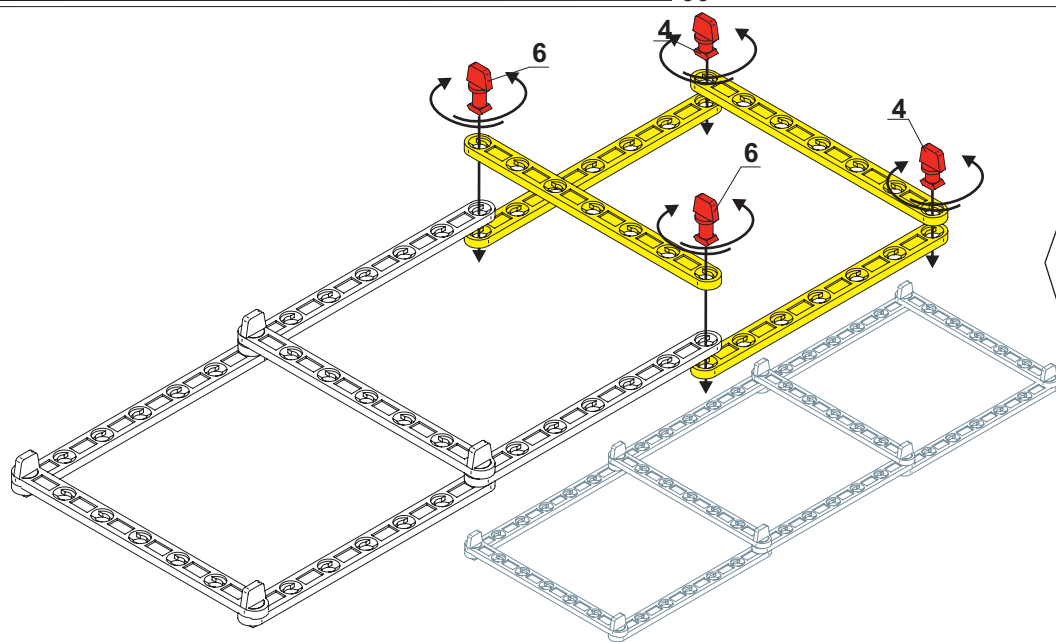

- 4**
-  90
 - x2 - 38531
 -  6
 - x2 - 36324

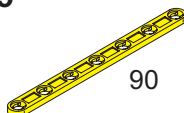

- 5**
-  90
 - x4 - 38531
 -  6
 - x2 - 36324
 -  4
 - x2 - 36323



x2 - KONSTRUKCIJA 1

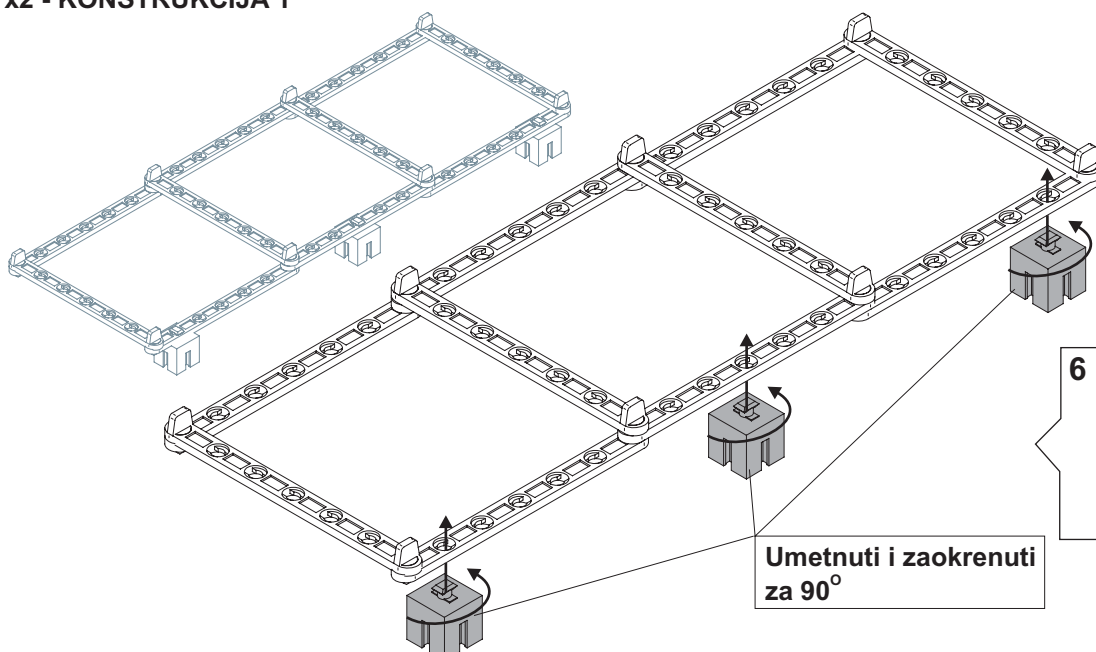

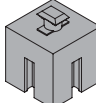
- 6**
-  3
 - x3 - 32850

Umetnuti i zaokrenuti za 90°

KONSTRUKCIJE- MOST "A"

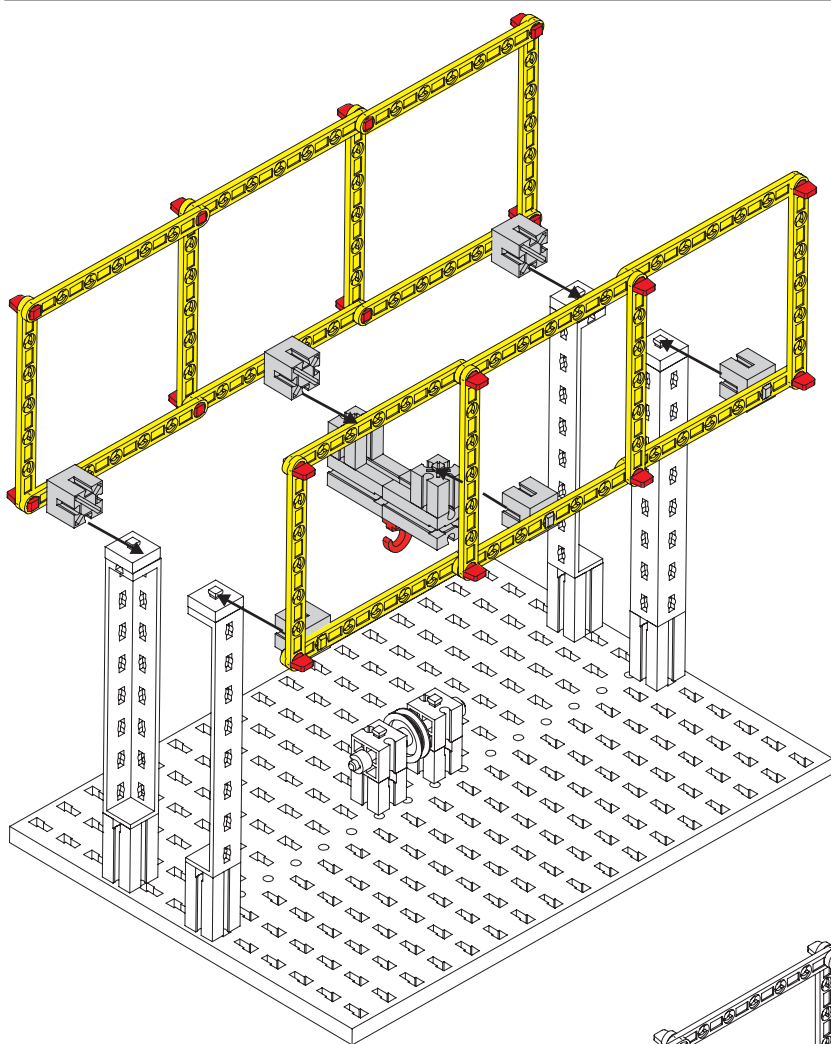

7

x2 konstrukcija 1

x1 sklop 2

postolje A

30 cm

špagica kratka

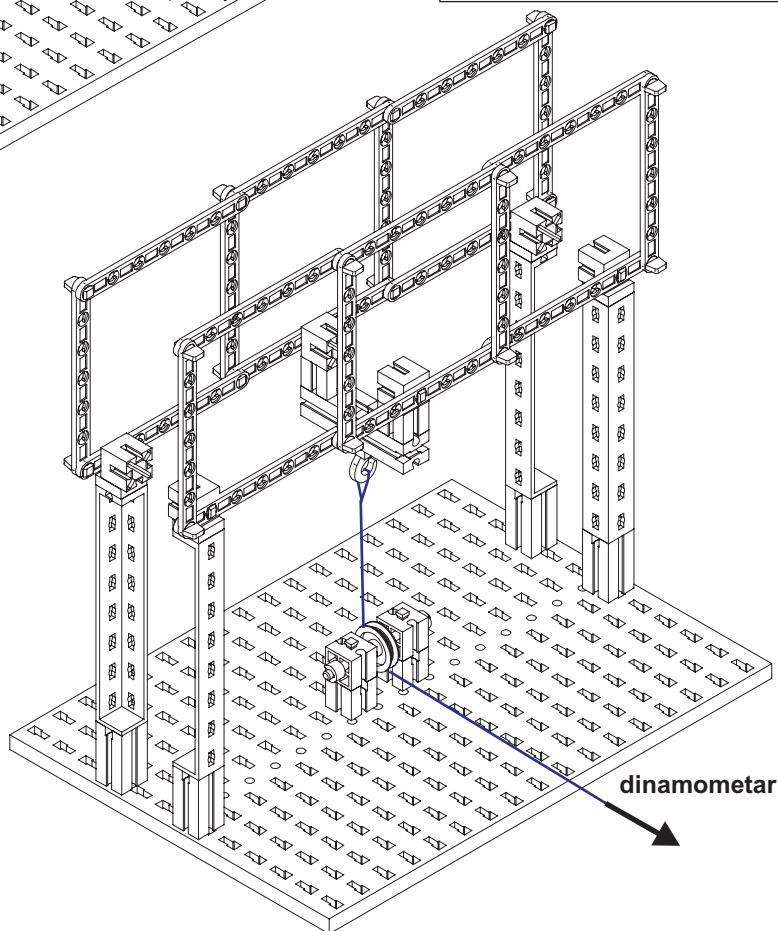

100 (x3)

KONSTRUKCIJE- MOST "B"

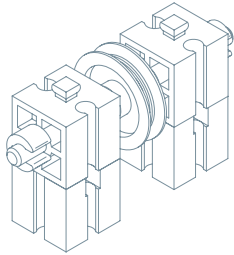
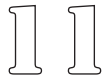

x1 sklop 1

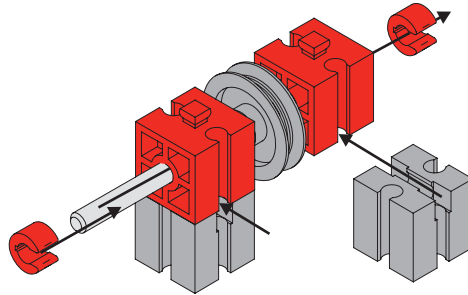

60

1



x2 - 37679

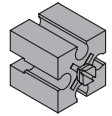

x2 - 32881

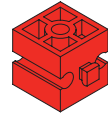

x2 - 32064

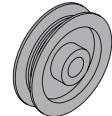

x1 - 35797

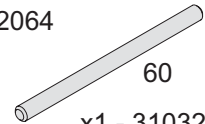

60

x1 - 31032

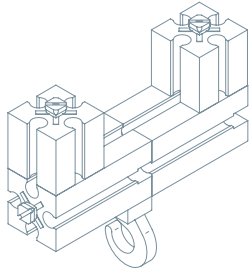

x1 sklop 2

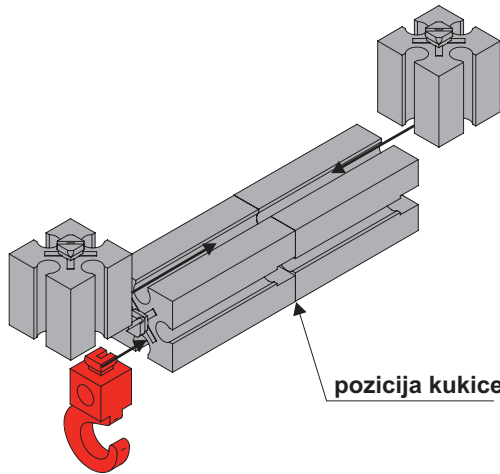

pozicija kukice

2



x2 - 32882

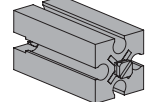

x2 - 32879



x1 - 38225

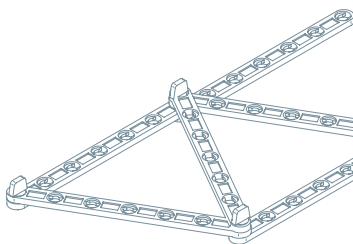

x2 -KONSTRUKCIJA 2

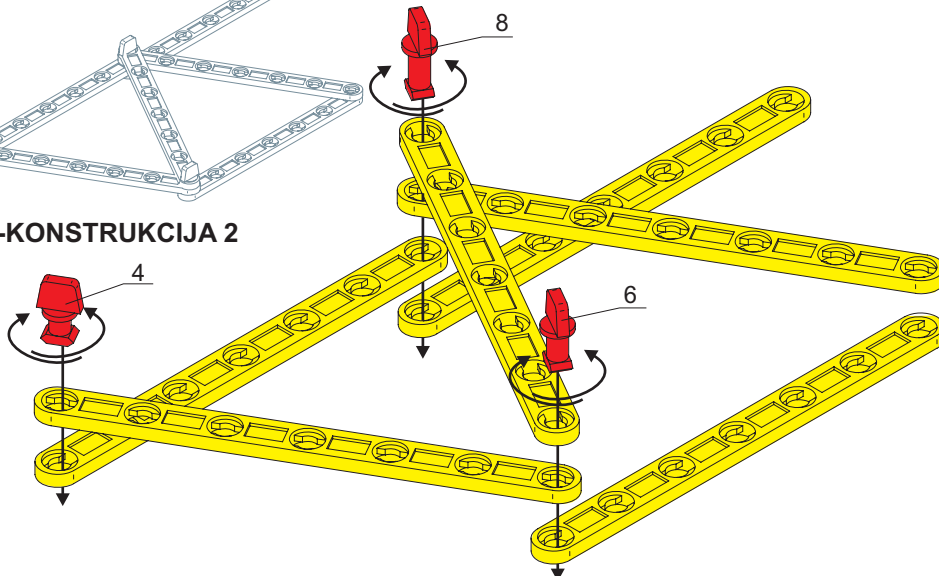

3

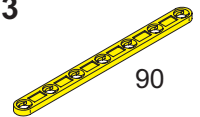

90

x6 - 38531



4

x1 - 36323



6

x1 - 36324

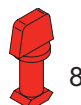

8

x1 - 36457

90

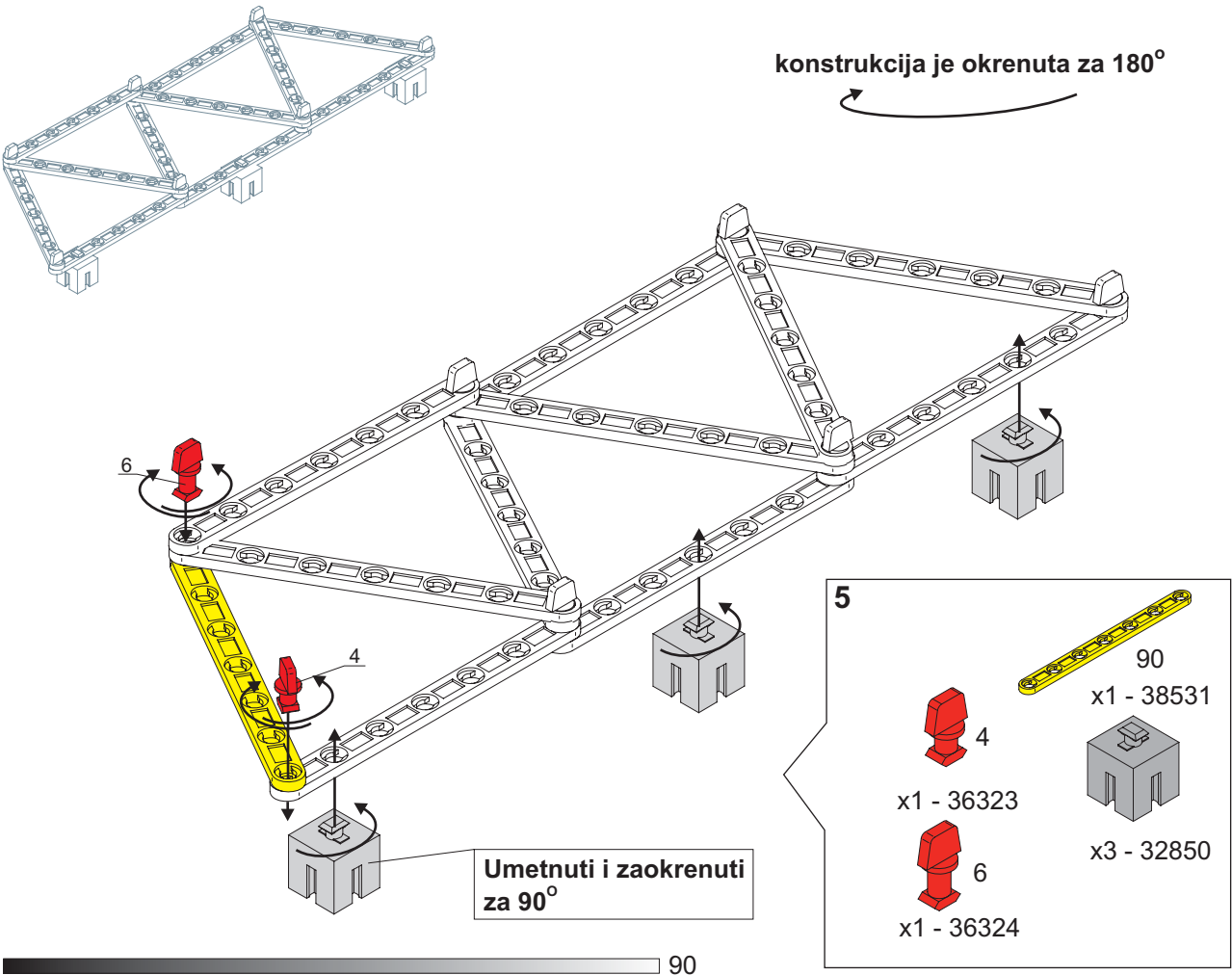
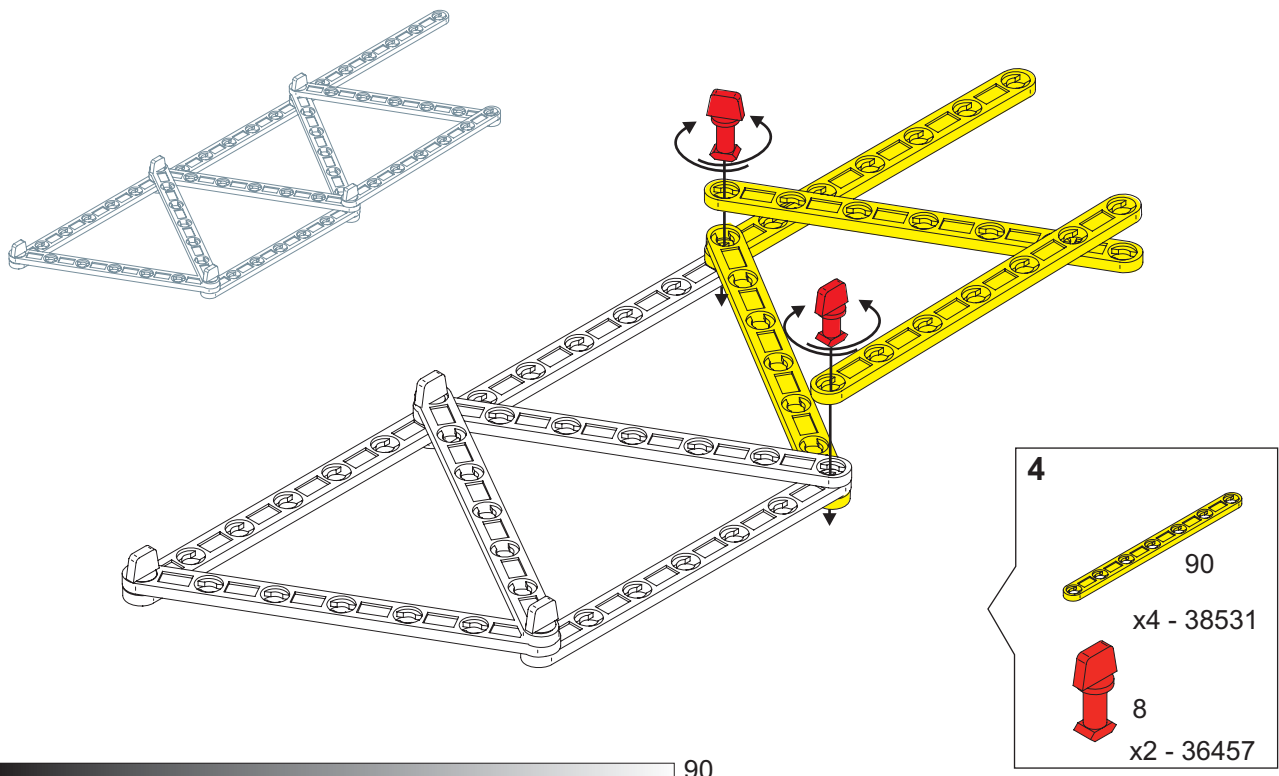

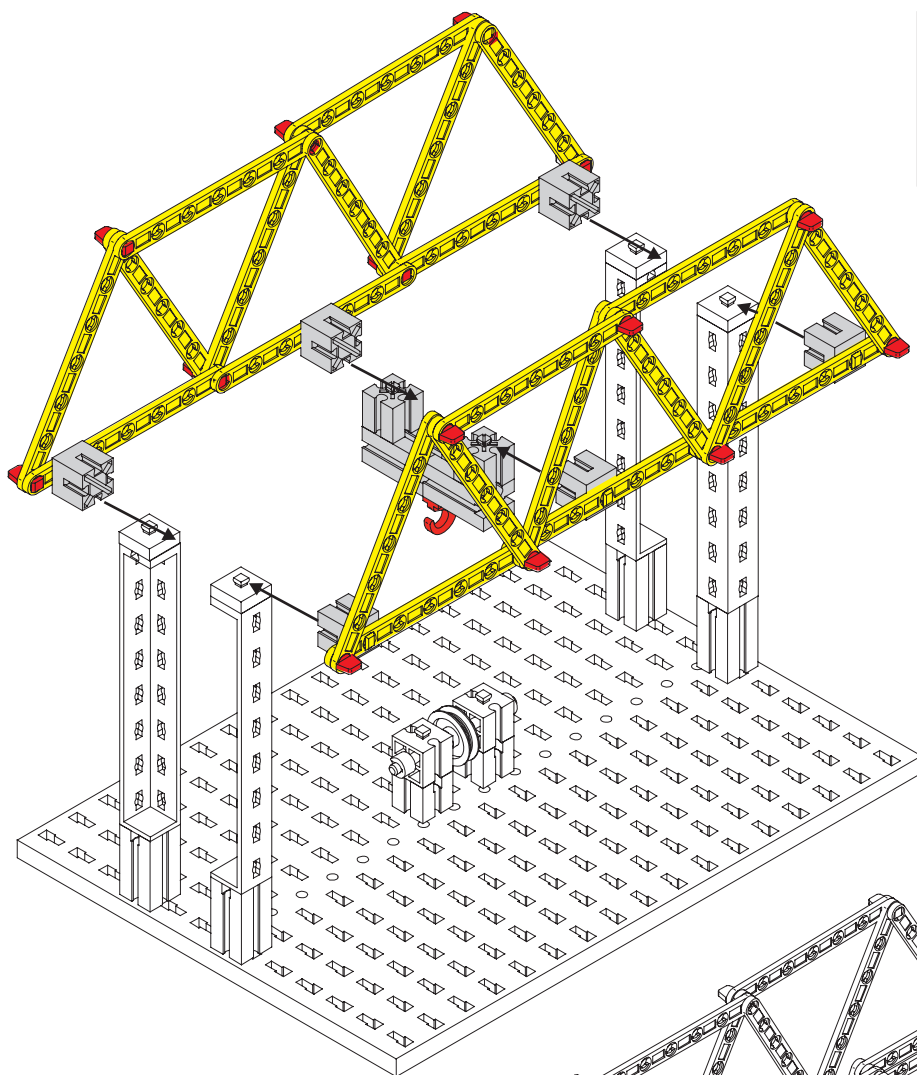

6

x2 konstrukcija 2

x1 sklop 2

postolje A

30 cm

špagica kratka

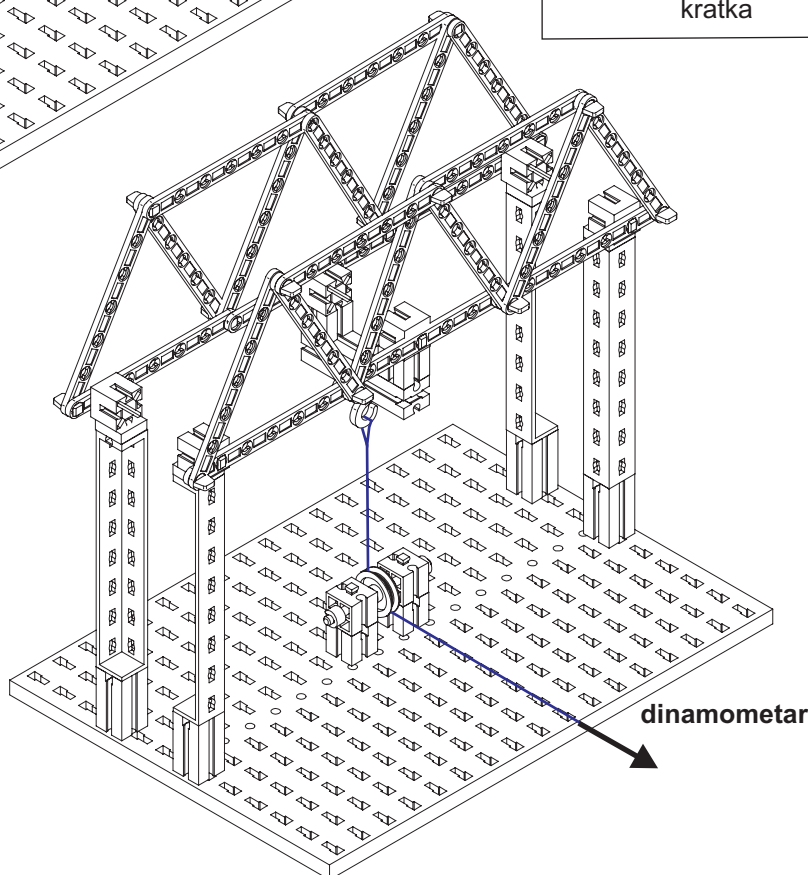

100 (x3)

KONSTRUKCIJE- MOST "C"

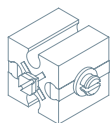

x2 sklop 3

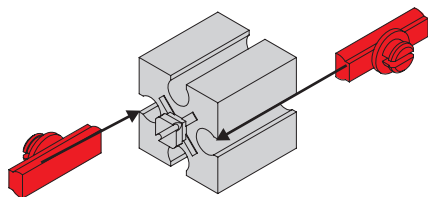

1

- x4 - 31848
- x2 - 32882

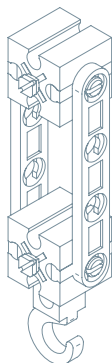

x1 sklop 4

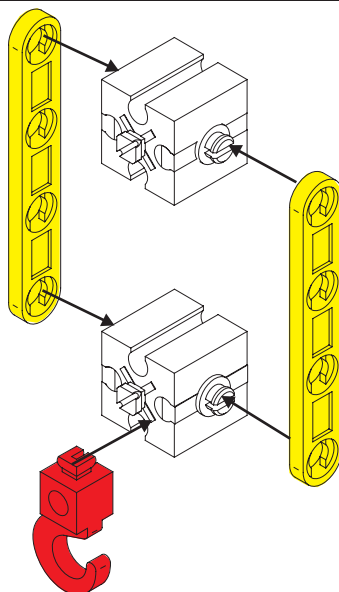

2

- 45
x2 - 38541
- x1 - 38225
- x2 sklop 3

45

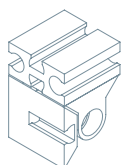

x1 sklop 5

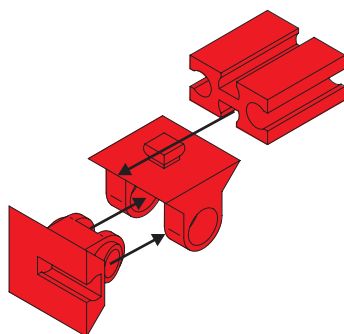

3

- x1 - 37468
- x1 - 31426
- x1 - 31436

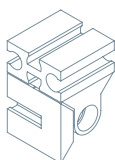

x1 sklop 6

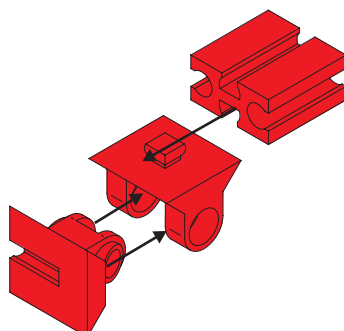

4

- x1 - 37468
- x1 - 31426
- x1 - 31436

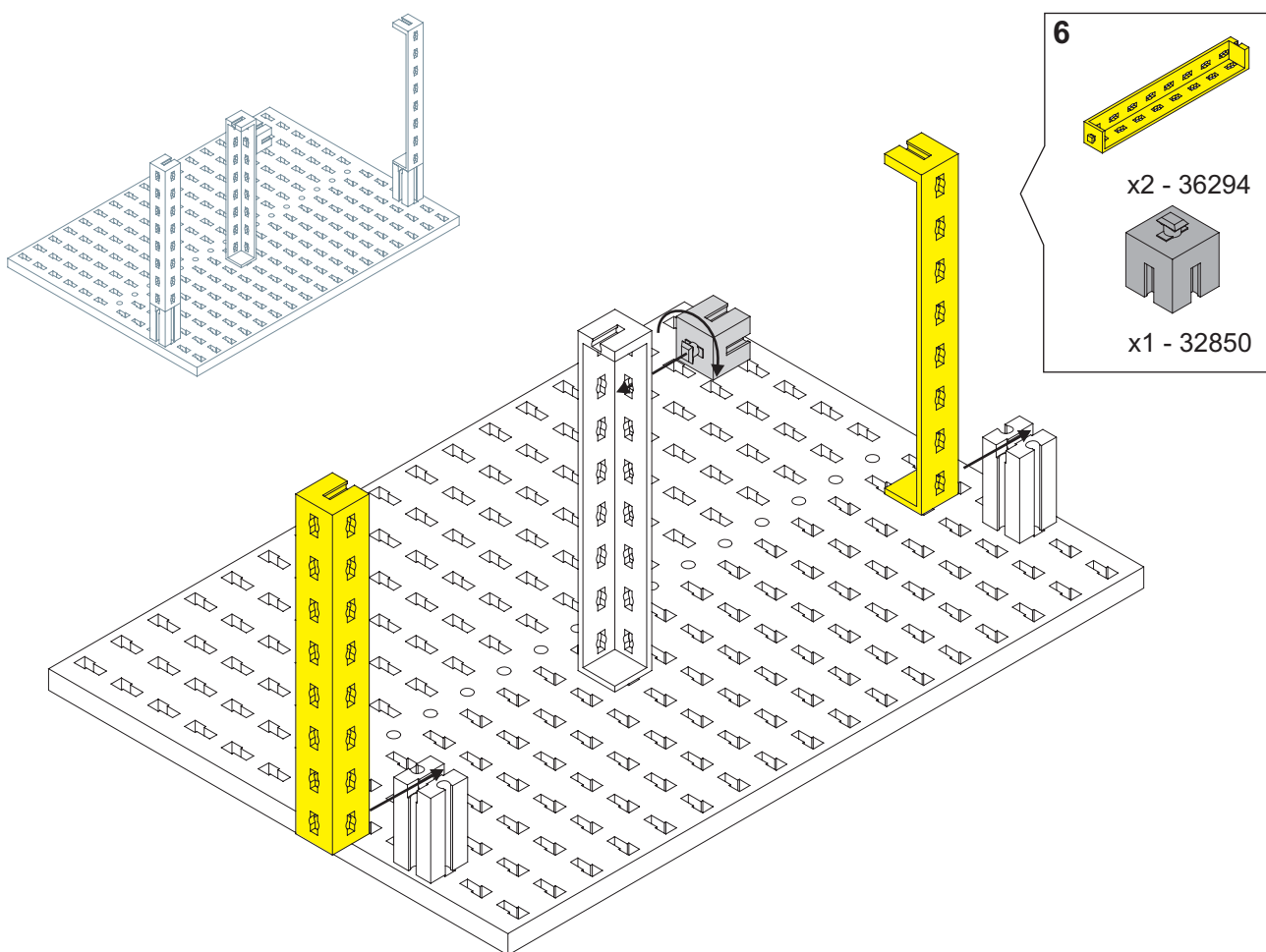
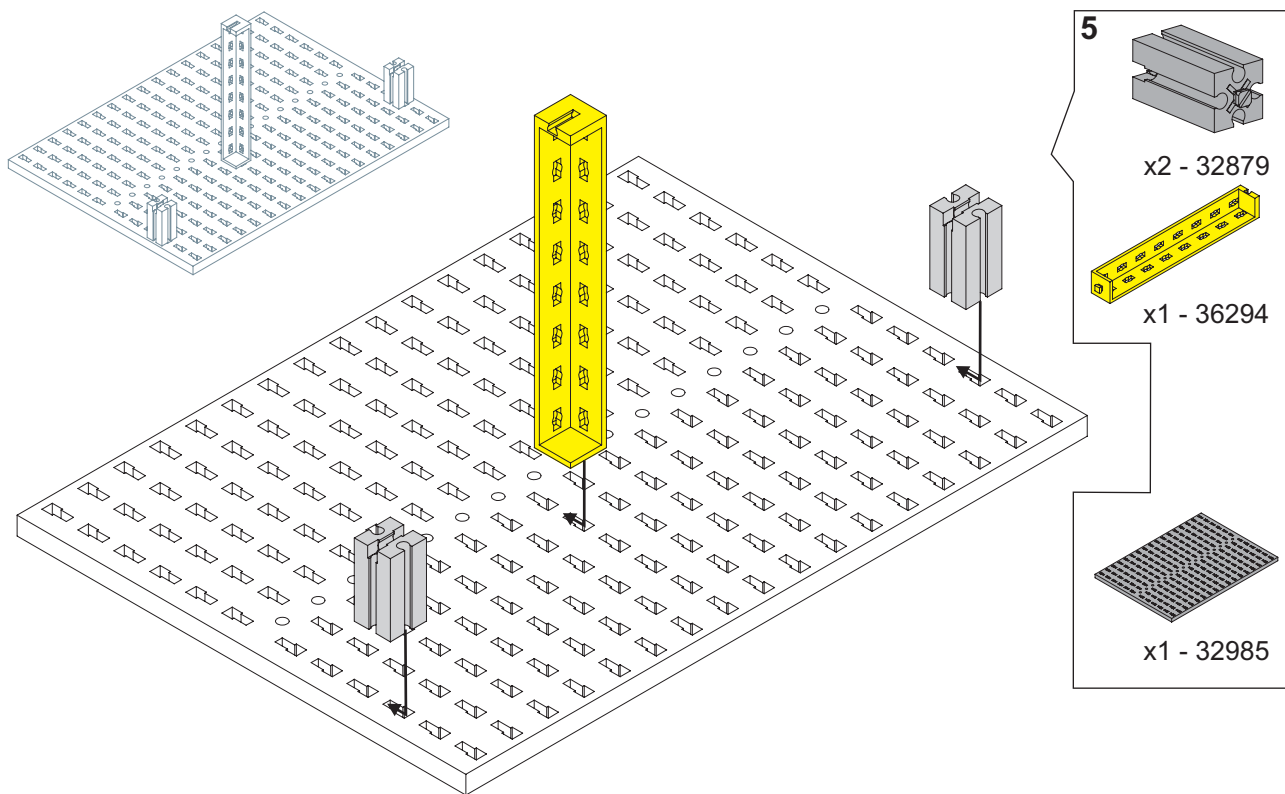

KONSTRUKCIJE- MOST "C"

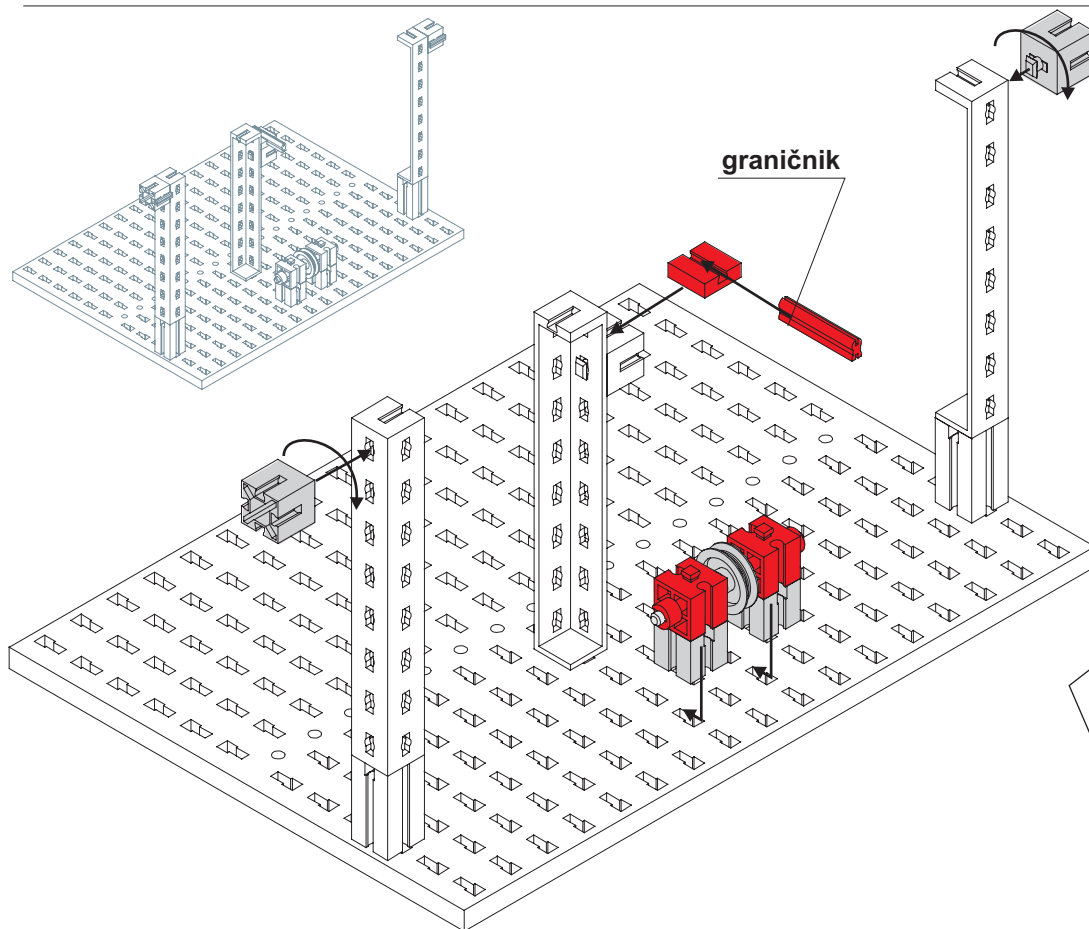

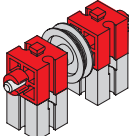
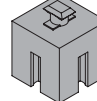
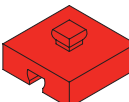
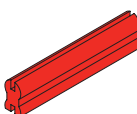

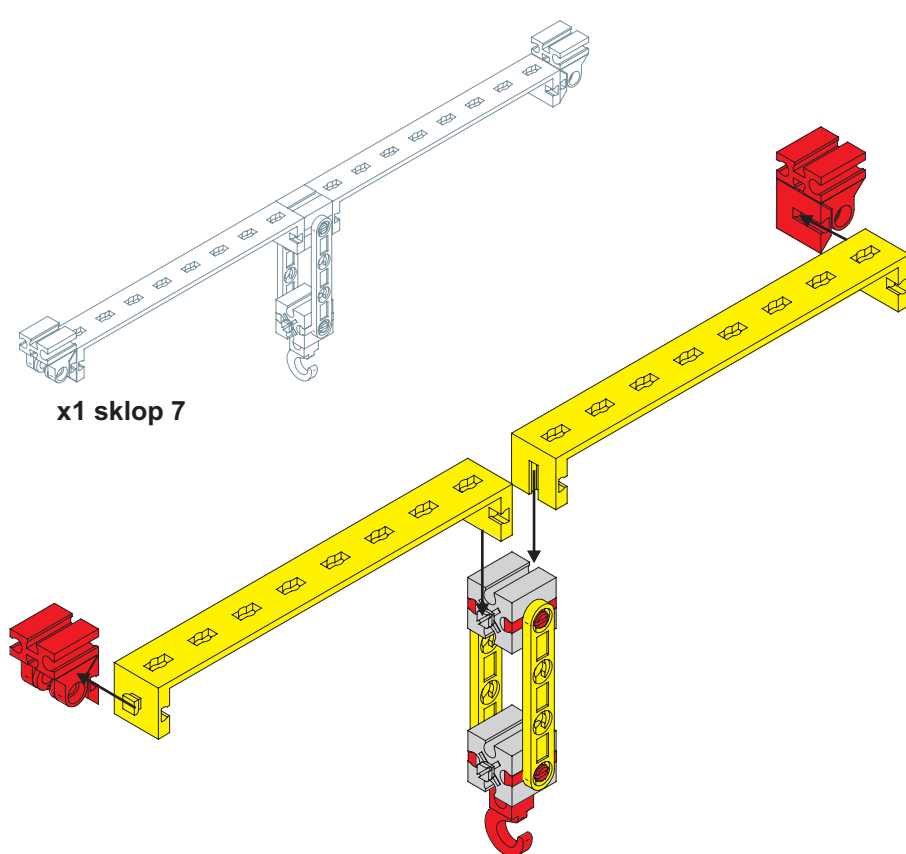
- 7**
-  x1 sklop 1
 -  x2 - 32850
 -  x1 - 37237
 -  x1 - 31061

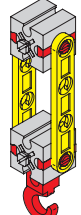

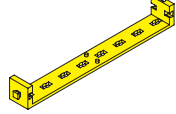
- 8**
-  x1 sklop 4
 -  x1 sklop 5
 -  x1 sklop 6
 -  x2 - 35054

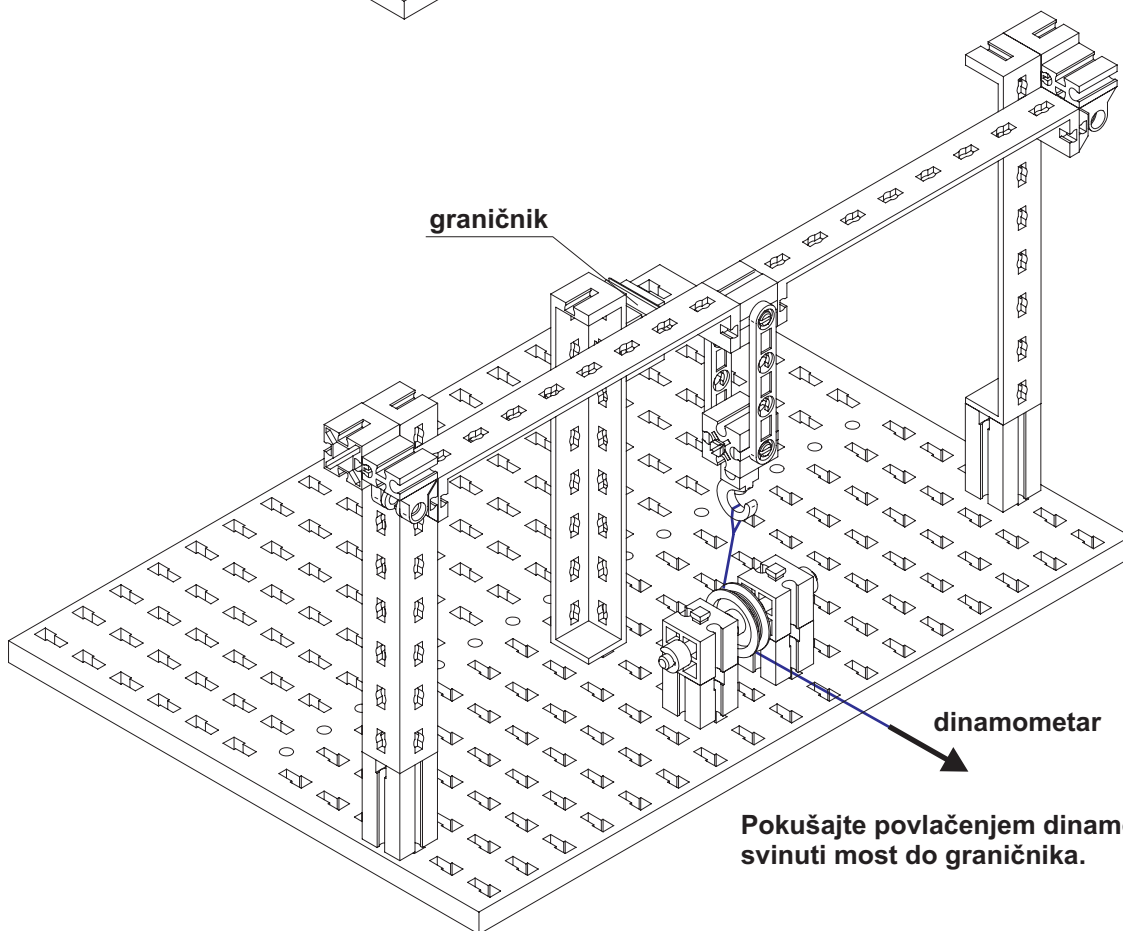
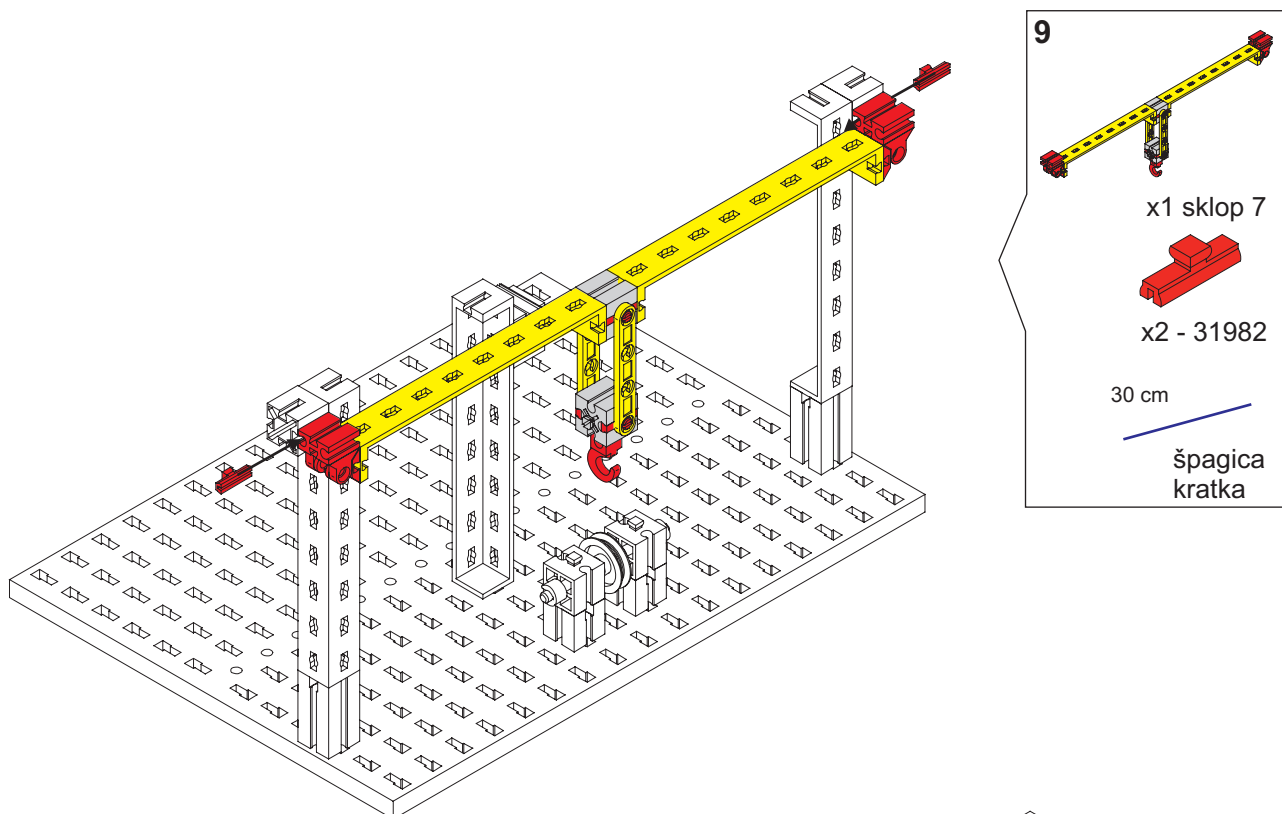

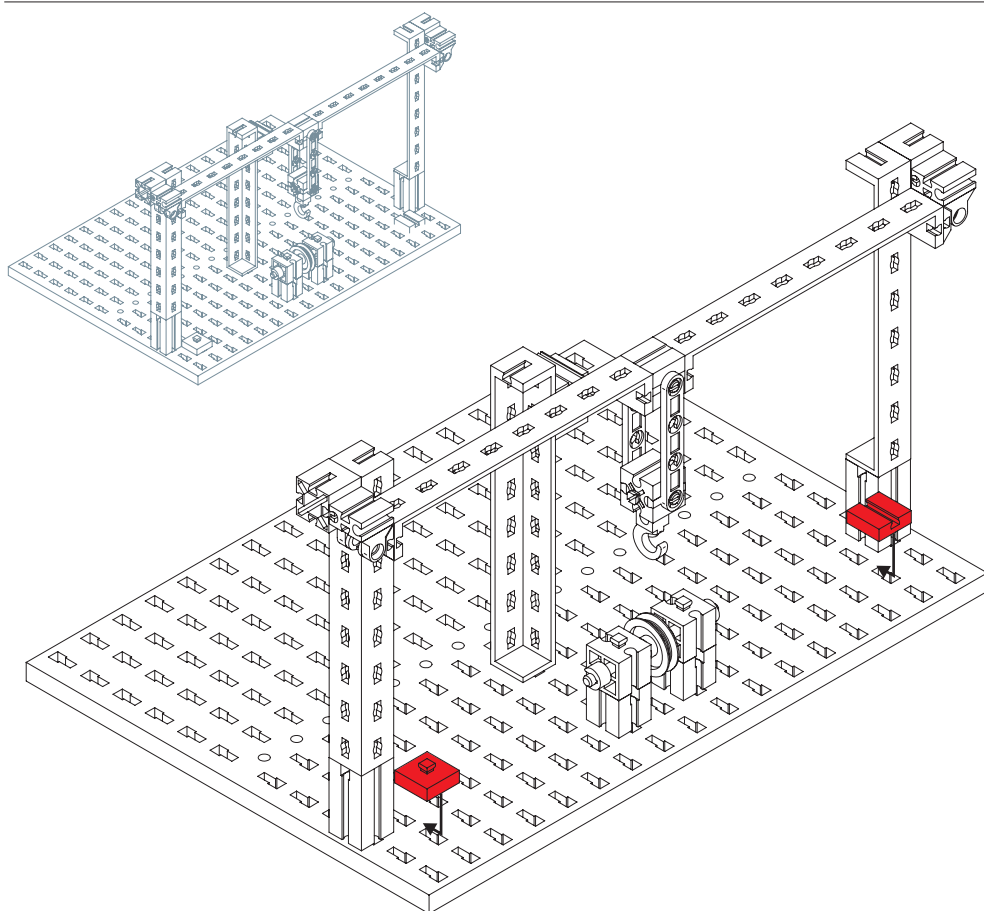

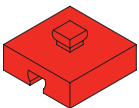
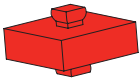
- 10**
-  x1 - 37237
 -  x1 - 37238

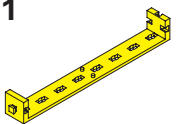
- 11**
-  x3 - 35054
30 cm
 - špagica kratka

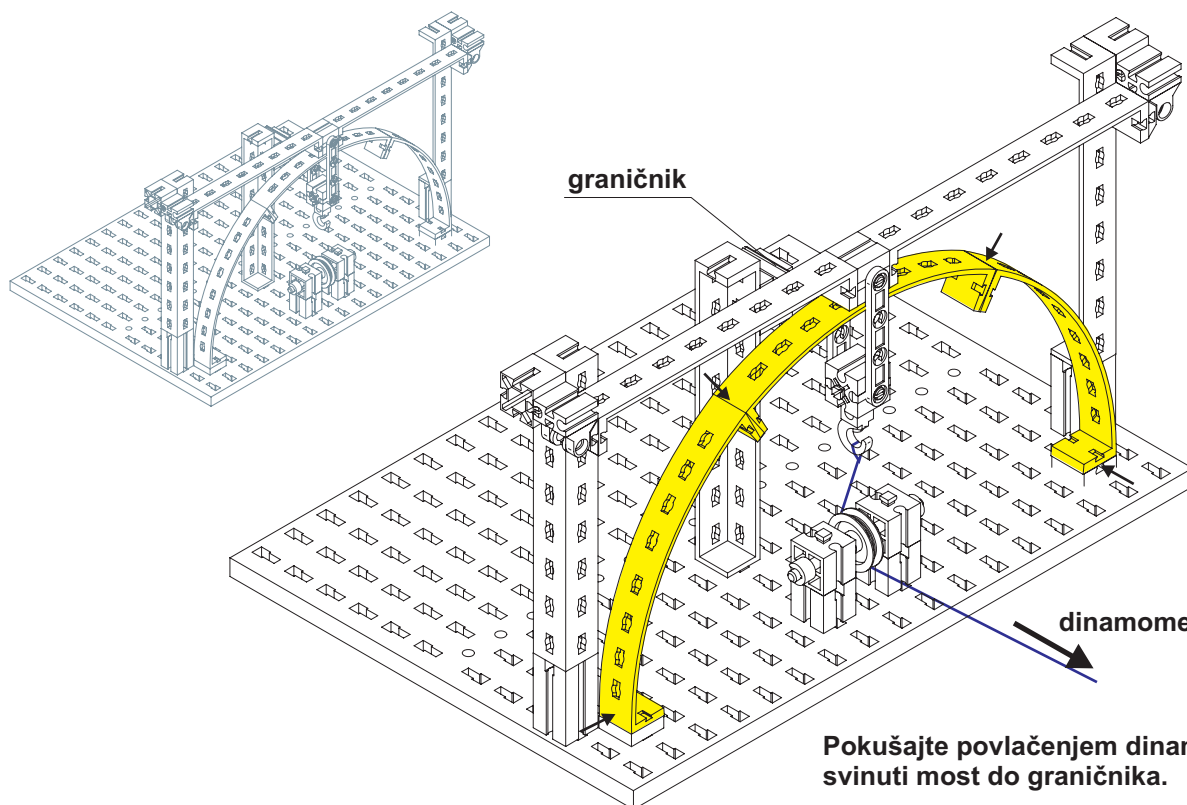

Pokušajte povlačenjem dinamometra svinuti most do graničnika.

100 (x3)

12

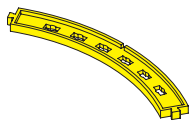

x3 - 35055

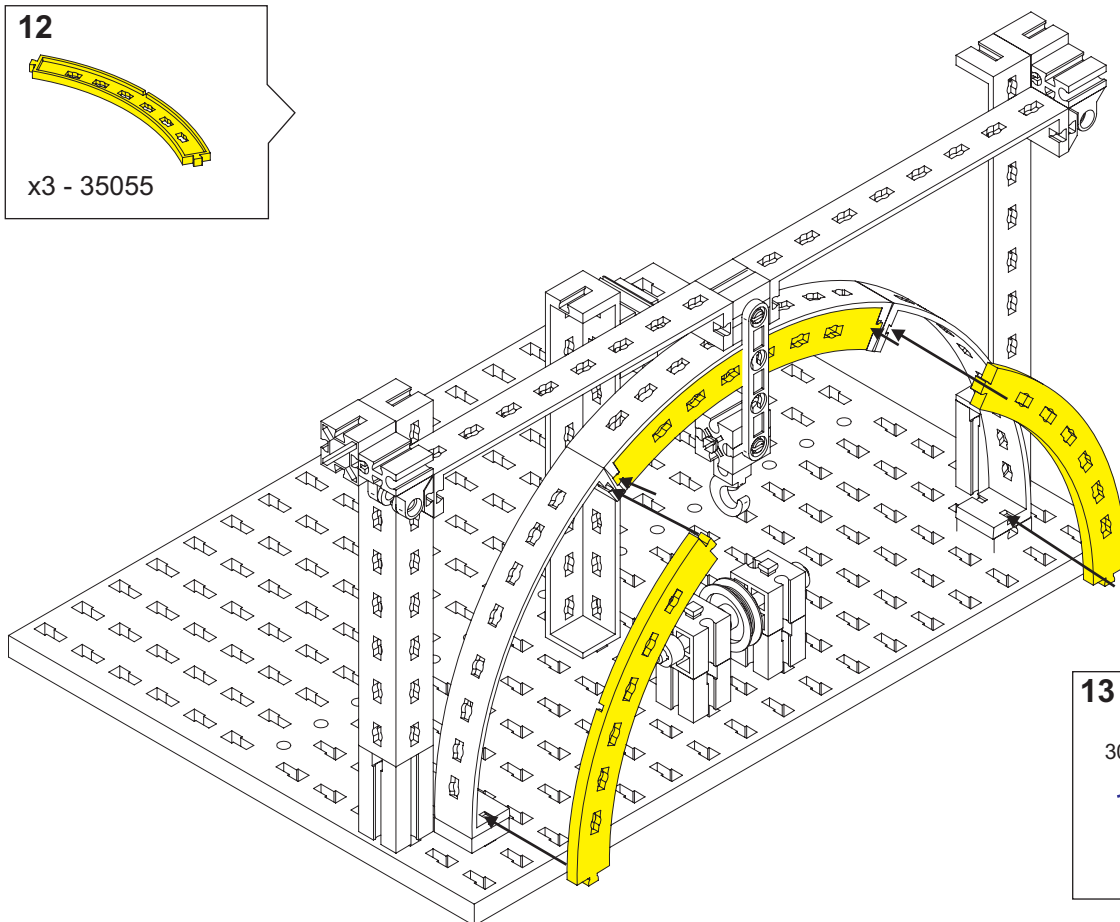

13

30 cm

špagica
kratka

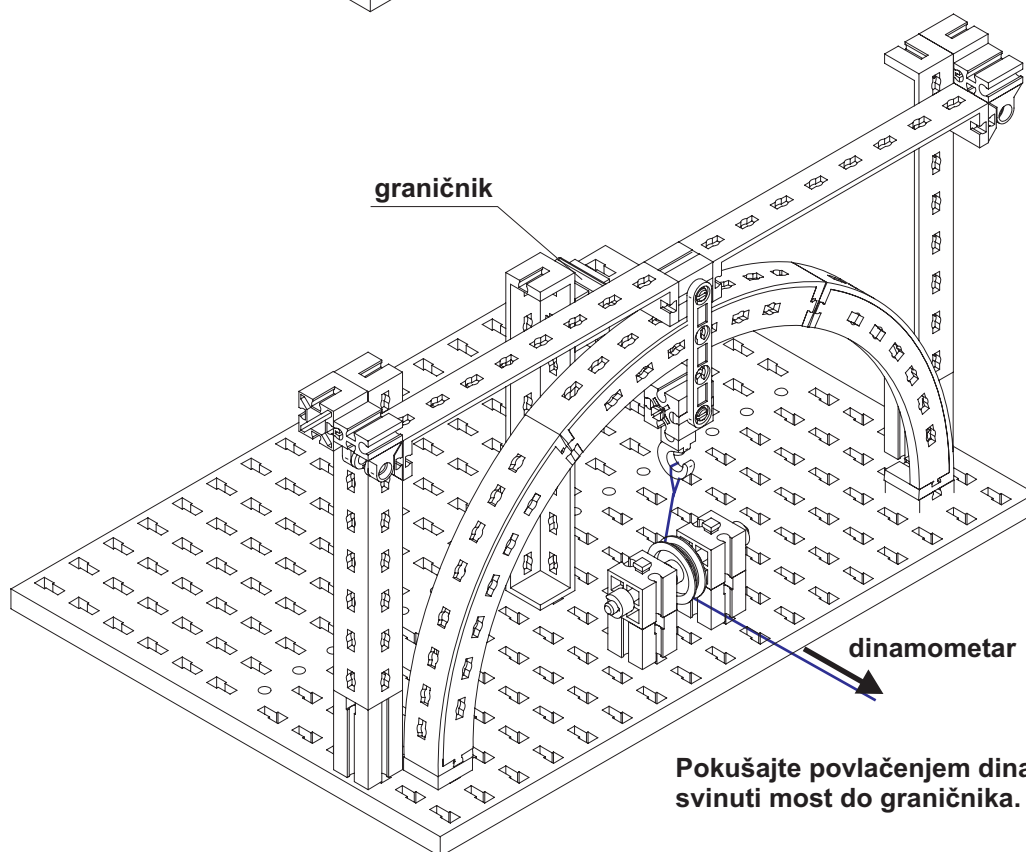

graničnik

dinamometar

**Pokušajte povlačenjem dinamometra
svinuti most do graničnika.**

100 (x3)

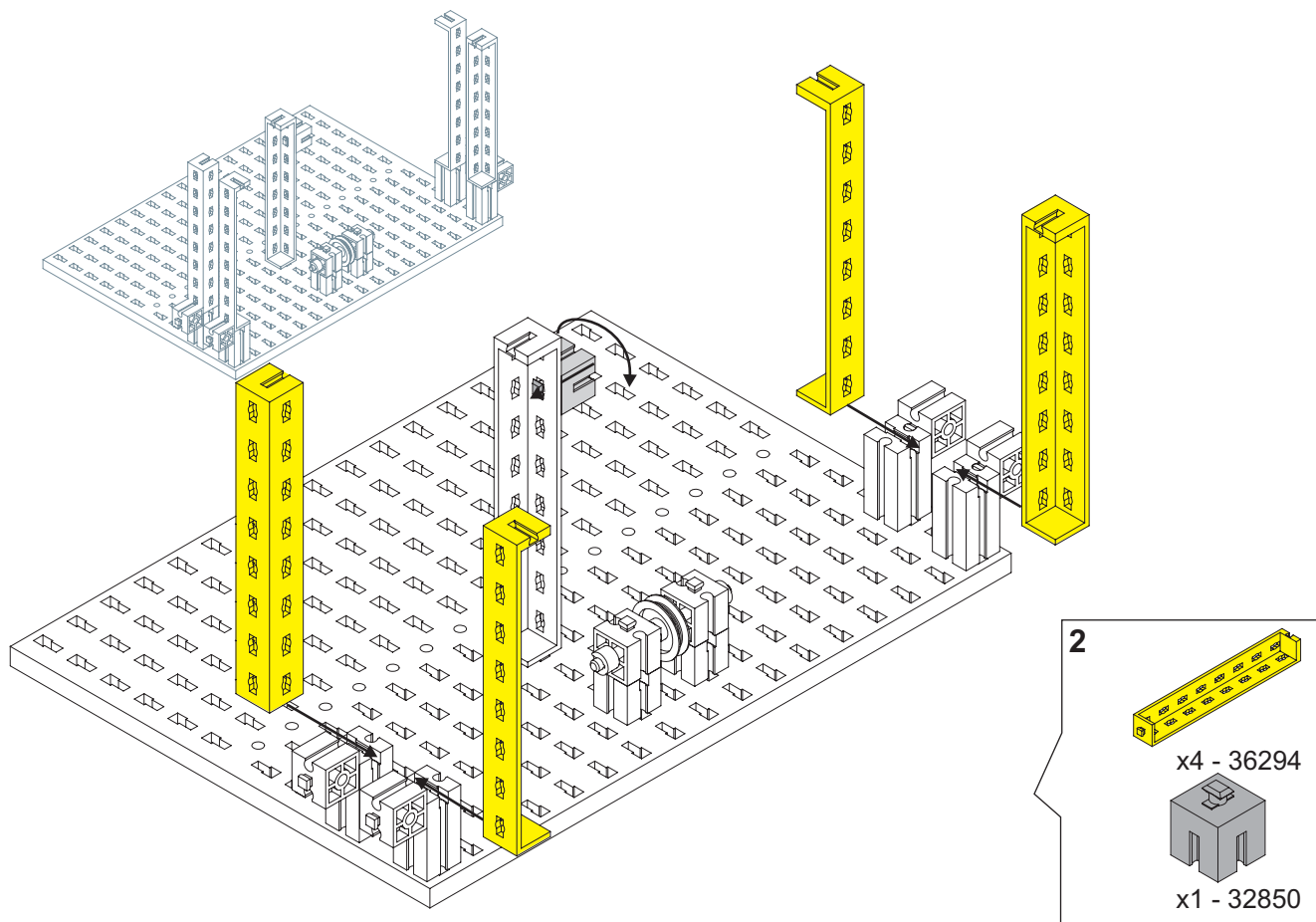
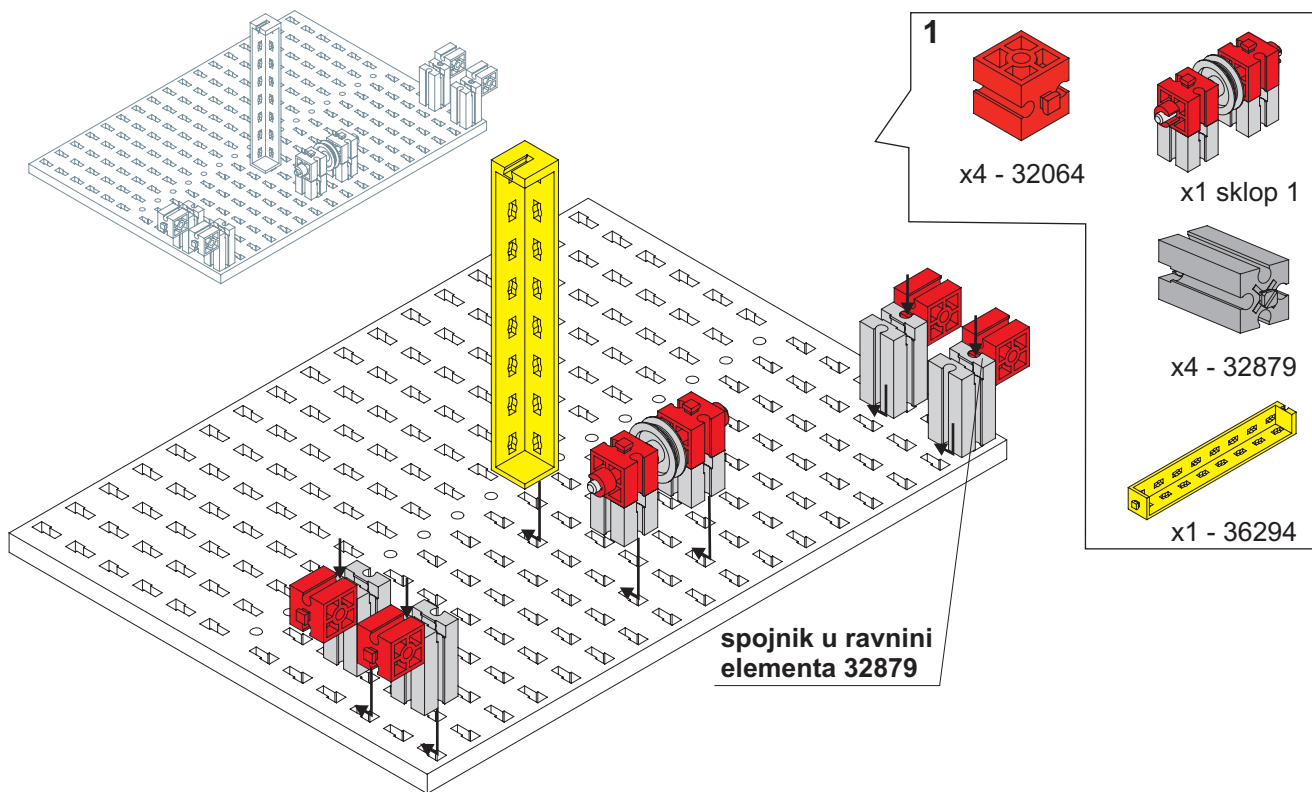

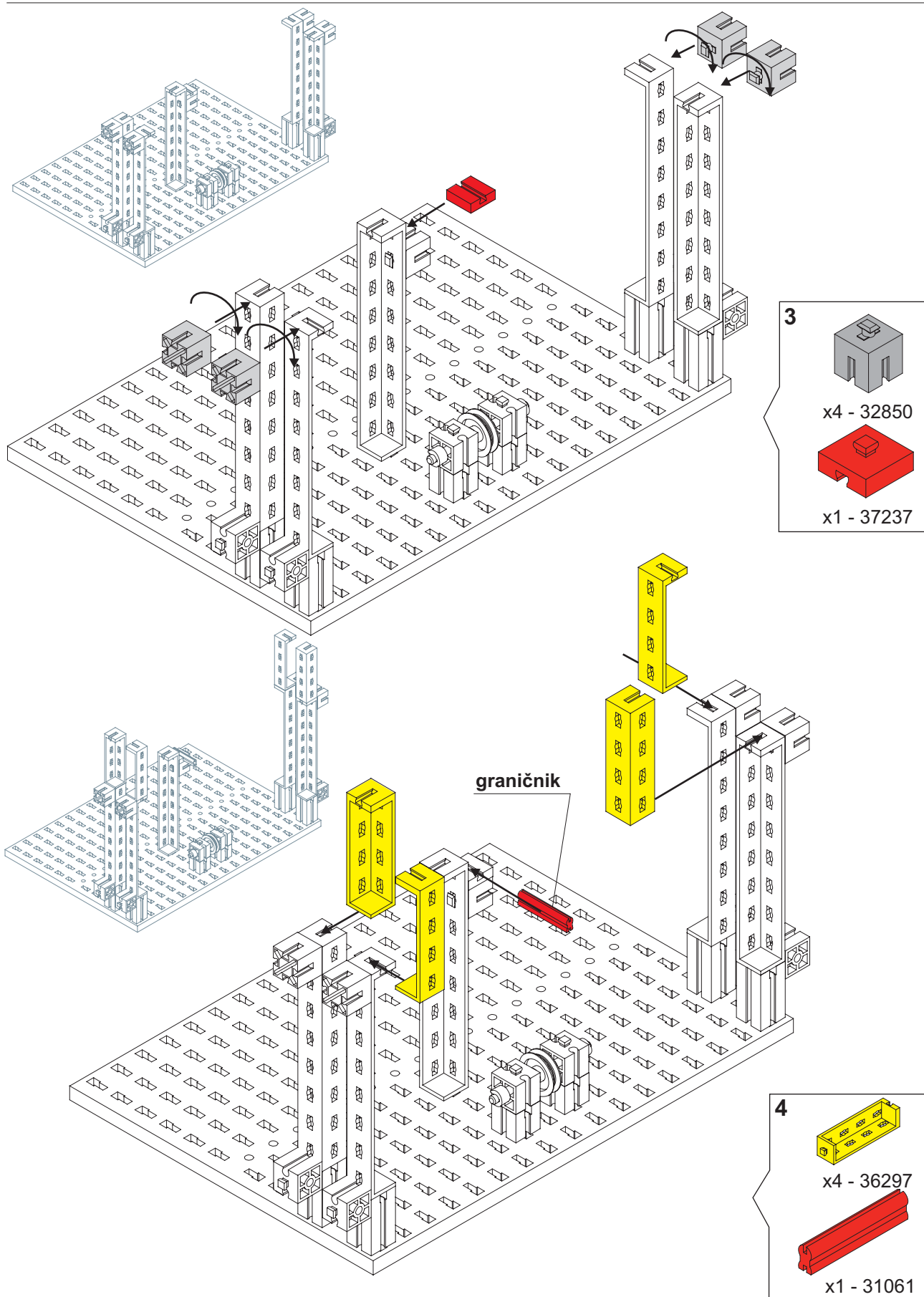

5

60
x2 - 31032

x4 - 37679

6

x4 - 31982

x1 sklop 7

7

x4 - 31058

90 cm x4 - 35031

x2 špagica duga

90 x2 - 31040

90

100 (x9)

